

AUDIO/VIDEO STEREO RECEIVER

KR-V9020

INSTRUCTION MANUAL

KENWOOD CORPORATION

KENWOOD

Introduction

Your choice of this product indicates that you are a devotee to excellence in sound reproduction.

We appreciate your patronage and take pride in the long tradition of quality components that our company represents. So that you can get the most out of your unit, we suggest that you take the time to read through this manual before you hook up and operate your system. This will acquaint you with operating features and system-connection considerations so that your listening pleasure will be enhanced right from the start. You will notice that in all aspects of planning, engineering, styling, operating convenience and adaptability we have sought to anticipate your needs and desires.

Keep this manual handy for future reference.

For your records

Record the serial number, found on the back of the unit, in the spaces designated on the warranty card, and in the space provided below. Refer to the model and serial numbers whenever you call upon your dealer for information or service on this product.

Model _____ Serial Number _____

Unpacking

Unpack the unit carefully and make sure that all accessories are put aside so they will not be lost.

Examine the unit for any possibility of shipping damage. If your unit is damaged or fails to operate, notify your dealer immediately. If your unit was shipped to you directly, notify the shipping company without delay. Only the consignee (the person or company receiving the unit) can file a claim against the carrier for shipping damage.

We recommend that you retain the original carton and packing materials for use should you transport or ship the unit in the future.

For the USA

Note to CATV system installer:

This reminder is provided to call the CATV system installer's attention to Article 820-22 of the NEC that provides guidelines for proper grounding and, in particular, specifies that the cable ground shall be connected to the grounding system of the building, as close to the point of cable entry as practical.

Accessories

FM indoor antenna 1 AM loop antenna 1

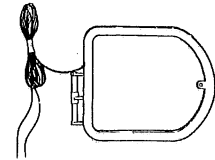
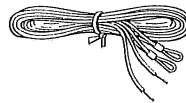

75 ohm/300 ohm antenna adaptor 1

Loop antenna holder 1

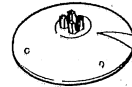
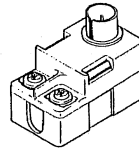

Batteries (R03/"AAA") 4

Remote control unit 1

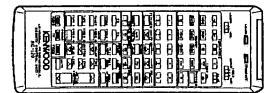
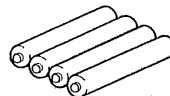

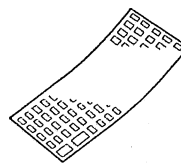

Remote control unit entry sheet 1



Contents

Caution: Read the pages marked  carefully to ensure safe operation.

Introduction	2	Listening to broadcasts	20
 Before applying power	3	Graphic equalizer operation	24
 Safety precautions	3	Playing video sources	26
 IMPORTANT SAFEGUARDS	4	Surround effects	28
System connections	6	System memory	32
Speaker connections	8	On-screen display	33
Antenna connections	10	Remote control operation	35
FM DE-EMPHASIS/CHANNEL SPACE switch	11	In case of difficulty	42
System control operation	12	Specifications	43

⚠ Caution: Read this page carefully to ensure safe operation.

Before applying power

For the U.S.A. and Canada

Important!

Units shipped to the U.S.A. and Canada are designed for operation on 120 volts AC only.

Safety precaution for a Polarized AC plug

However, some products may be supplied with a non-polarized plug.

CAUTION: TO PREVENT ELECTRIC SHOCK DO NOT USE THIS (POLARIZED) PLUG WITH AN EXTENSION CORD, RECEPTACLE OR OTHER OUTLET UNLESS THE BLADES CAN BE FULLY INSERTED TO PREVENT BLADE EXPOSURE.

For the United Kingdom

Important!

Units shipped to the U.K. are designed for operation on 240 volts AC only.

The mains plug must be removed from the wall socket prior to any internal examination.

The wires in this mains lead are coloured in accordance with the following code:

Blue Neutral
Brown Live

The wires in this mains lead must be connected to the terminals in the plug as follows:

Wire colour	Plug terminal marking
Blue	N or Black
Brown	L or Red

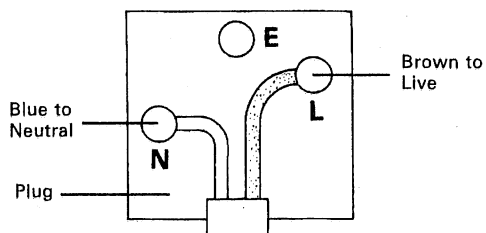

Notes:

1. If a 13-amp plug is used, this must be fitted with a 5-amp fuse.
2. If a 3-pin plug with earthing contact is used, no wire must be connected to the E terminal.

For Australia and Europe

Important!

Units shipped to Australia are designed for operation on 240 V AC only.

Units shipped to Europe are designed for operation on 220 V AC only.

For other countries

Important!

Units shipped to countries other than the above countries are equipped with an AC voltage selector switch on the rear panel. Refer to the following paragraph for the proper setting of this switch.

AC voltage selection

This unit operates on 110-120 or 220-240 volts AC. The AC voltage selector switch Type A or Type B on the rear panel is set to the voltage that prevails in the area to which the unit is shipped. Before connecting the power cord to your AC outlet, make sure that the setting position of this switch matches your line voltage. If not, it must be set to your voltage in accordance with the following direction.

Note:

Our warranty does not cover damage caused by excessive line voltage due to improper setting of the AC voltage selector switch.

AC voltage selector switch

Type A

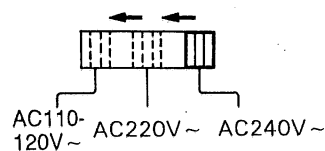



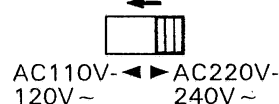

Type B



Move switch lever to match your line voltage with a small screwdriver or other pointed tool.

Safety precautions

WARNING: TO PREVENT FIRE OR SHOCK HAZARD, DO NOT EXPOSE THIS APPLIANCE TO RAIN OR MOISTURE.

 <div style="border: 1px solid black; padding: 5px; text-align: center;"> CAUTION <small>RISK OF ELECTRIC SHOCK DO NOT OPEN</small> </div> 	<p>CAUTION: TO REDUCE THE RISK OF ELECTRIC SHOCK, DO NOT REMOVE COVER (OR BACK). NO USER-SERVICEABLE PARTS INSIDE, REFER SERVICING TO QUALIFIED SERVICE PERSONNEL.</p>
	<p>THE LIGHTNING FLASH WITH ARROWHEAD SYMBOL, WITHIN AN EQUILATERAL TRIANGLE, IS INTENDED TO ALERT THE USER TO THE PRESENCE OF UNINSULATED "DANGEROUS VOLTAGE" WITHIN THE PRODUCT'S ENCLOSURE THAT MAY BE OF SUFFICIENT MAGNITUDE TO CONSTITUTE A RISK OF ELECTRIC SHOCK TO PERSONS.</p>
	<p>THE EXCLAMATION POINT WITHIN AN EQUILATERAL TRIANGLE IS INTENDED TO ALERT THE USER TO THE PRESENCE OF IMPORTANT OPERATING AND MAINTENANCE (SERVICING) INSTRUCTIONS IN THE LITERATURE ACCOMPANYING THE APPLIANCE</p>

IMPORTANT SAFEGUARDS

⚠ Caution : Read this page carefully to ensure safe operation.

Please read all of the safety and operating instructions before operating this unit. For best results, follow all warnings placed on the unit and adhere to the operating and use instructions. These safety and operating instructions should be retained for future reference.

1. Power sources — The unit should be connected to a power supply only of the type described in the operating instructions or as marked on the appliance.

2. Power-cord protection — Power-supply cords should be routed so that they are not likely to be walked on or pinched by items placed upon or against them, pay particular attention to cords at plugs, convenience receptacles, and the point where they exit from the unit.

Never pull or stretch the cord.

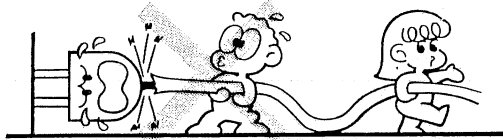

3. Grounding or polarization — The precautions should be taken so that the grounding or polarization means of this unit is not defeated.

4. Ventilation — The unit should be situated so that its location or position does not interfere with its proper ventilation.

To maintain good ventilation, do not put records or a table-cloth on the unit. Place the unit at least 10 cm away from the walls.

Do not use the unit on a bed, sofa, rug or similar surface that may block the ventilation openings.

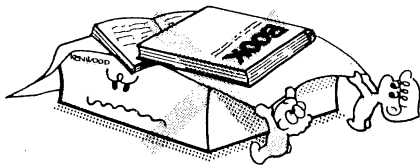

5. Water and moisture — The unit should not be used near water — for example, near a bathtub, washbowl, kitchen sink, laundry tub, in a wet basement, or near a swimming pool, etc.

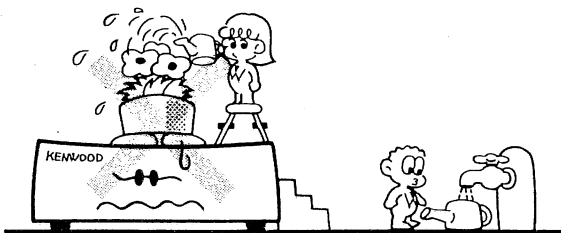

6. Temperature — The unit may not function properly if used at extremely low, or freezing temperatures. The ideal ambient temperature is above +5°C.

7. Heat — The unit should be situated away from heat sources such as radiators, heat registers, stoves, or other units (including amplifiers) that produce heat.

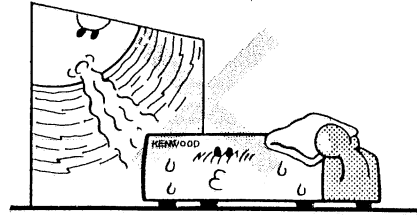

8. Electric shock — Care should be taken so that objects do not fall and liquid is not spilled into the enclosure through openings. If a metal object, such as a hair pin or a needle, comes into contact with the inside of this unit, a dangerous electric shock may result. For families with children, never permit children to put anything, especially metal, inside this unit.

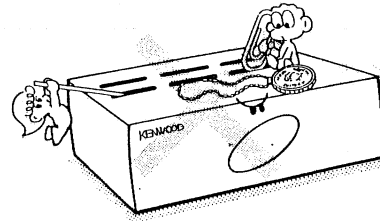

9. Enclosure removal — Never remove the enclosure. If the internal parts are touched accidentally, a serious electric shock might occur.

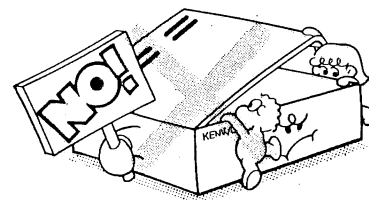

10. Magnetic fields — Keep the unit away from sources of magnetic fields such as TV sets, speaker systems, radios, motorized toys or magnetized objects.

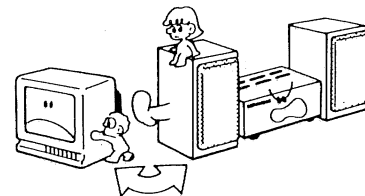

11. Cleaning — Do not use volatile solvents such as alcohol, paint thinner, gasoline, or benzene, etc. to clean the cabinet. Use a clean dry cloth.

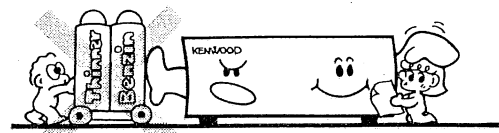

⚠ Caution: Read this page carefully to ensure safe operation.

12. Carts and stands — An appliance and cart combination should be moved with care. Quick stops, excessive force, and uneven surfaces may cause the appliance and cart combination to overturn.



13. Nonuse periods — The power cord of the unit should be unplugged from the outlet when left unused for a long period of time.

14. Abnormal smell — If an abnormal smell or smoke is detected, immediately turn the power OFF and pull out the power cord. Contact your dealer or nearest service center.

POWER OFF!

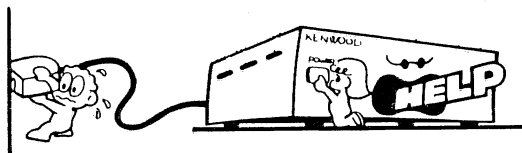

15. Damage requiring service — The unit should be serviced by qualified service personnel when:

- A. The power-supply cord or the plug has been damaged; or
- B. Objects have fallen, or liquid has been spilled into the unit; or
- C. The unit has been exposed to rain; or
- D. The unit does not appear to operate normally or exhibits a marked change in performance; or
- E. The unit has been dropped, or the enclosure damaged.

16. Servicing — The user should not attempt to service the unit beyond that described in the operating instructions. All other servicing should be referred to qualified service personnel.

17. Outdoor antenna grounding — If an outside antenna is connected to the receiver, be sure the antenna system is grounded so as to provide some protection against voltage surges and built up static charges. Section 810 of the National Electrical Code, ANSI/ NFPA No. 70—1984, provides information with respect to proper grounding of the mast and supporting structure, grounding of the lead-in wire to an antenna discharge unit, size of grounding con-

ductors, location of antenna-discharge unit, connection to grounding electrodes, and requirements for the grounding electrode. See Figure.

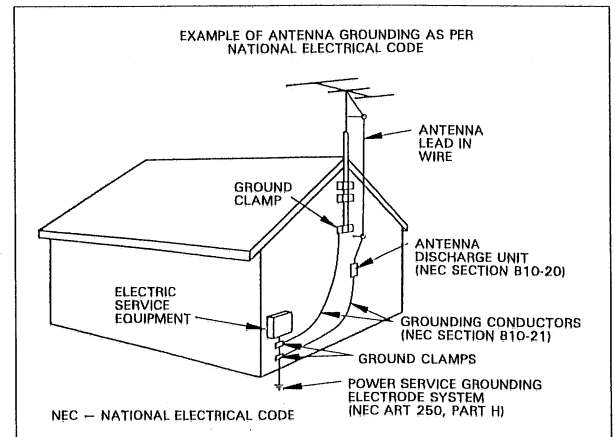

18. Power lines — An outdoor antenna should be located away from power lines.

19. AC outlets — Do not connect other audio equipment with a power consumption larger than that specified to the AC outlet on the rear panel. Never connect other electrical units, such as an iron or toaster, to it to prevent fire or electric shock.

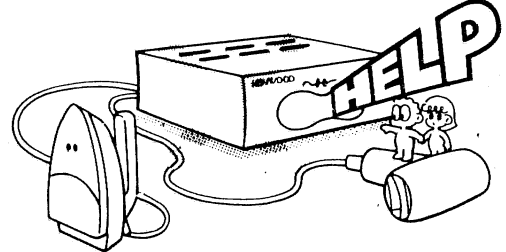

The maximum capacities indicated for the AC outlets on the rear panel of this unit are as follows.

SWITCHED outlets :200 W

Notes:

1. Item 3 is not required except for grounded or polarized equipment.

System connections

Make connections as shown in the diagram below. When connecting the related system components, refer also to the instruction manuals of the related components. Do not plug in the power lead until all connections are complete.

Connection of audio components

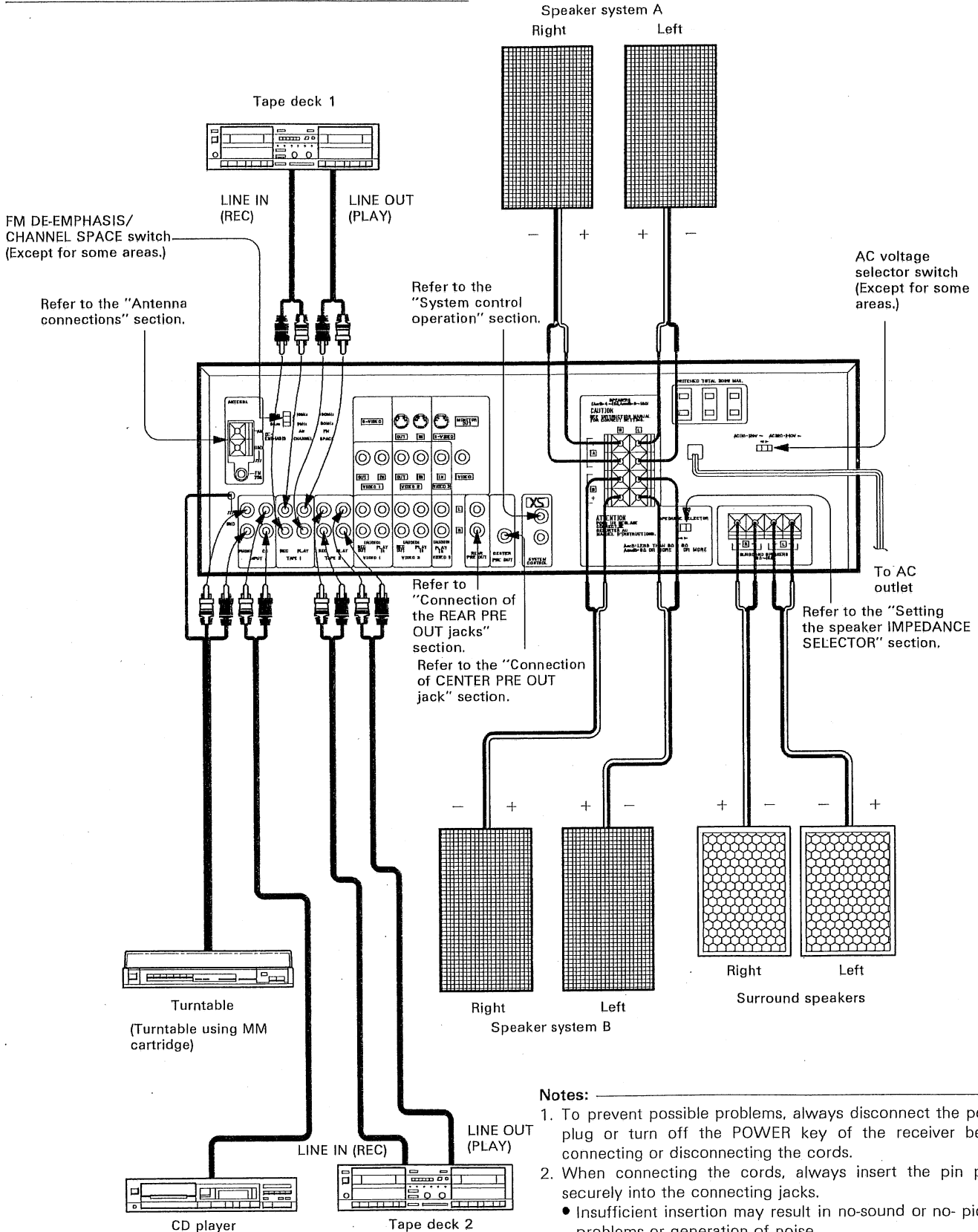

Notes:

1. To prevent possible problems, always disconnect the power plug or turn off the POWER key of the receiver before connecting or disconnecting the cords.
2. When connecting the cords, always insert the pin plugs securely into the connecting jacks.
 - Insufficient insertion may result in no-sound or no-picture problems or generation of noise.

Connection of video components

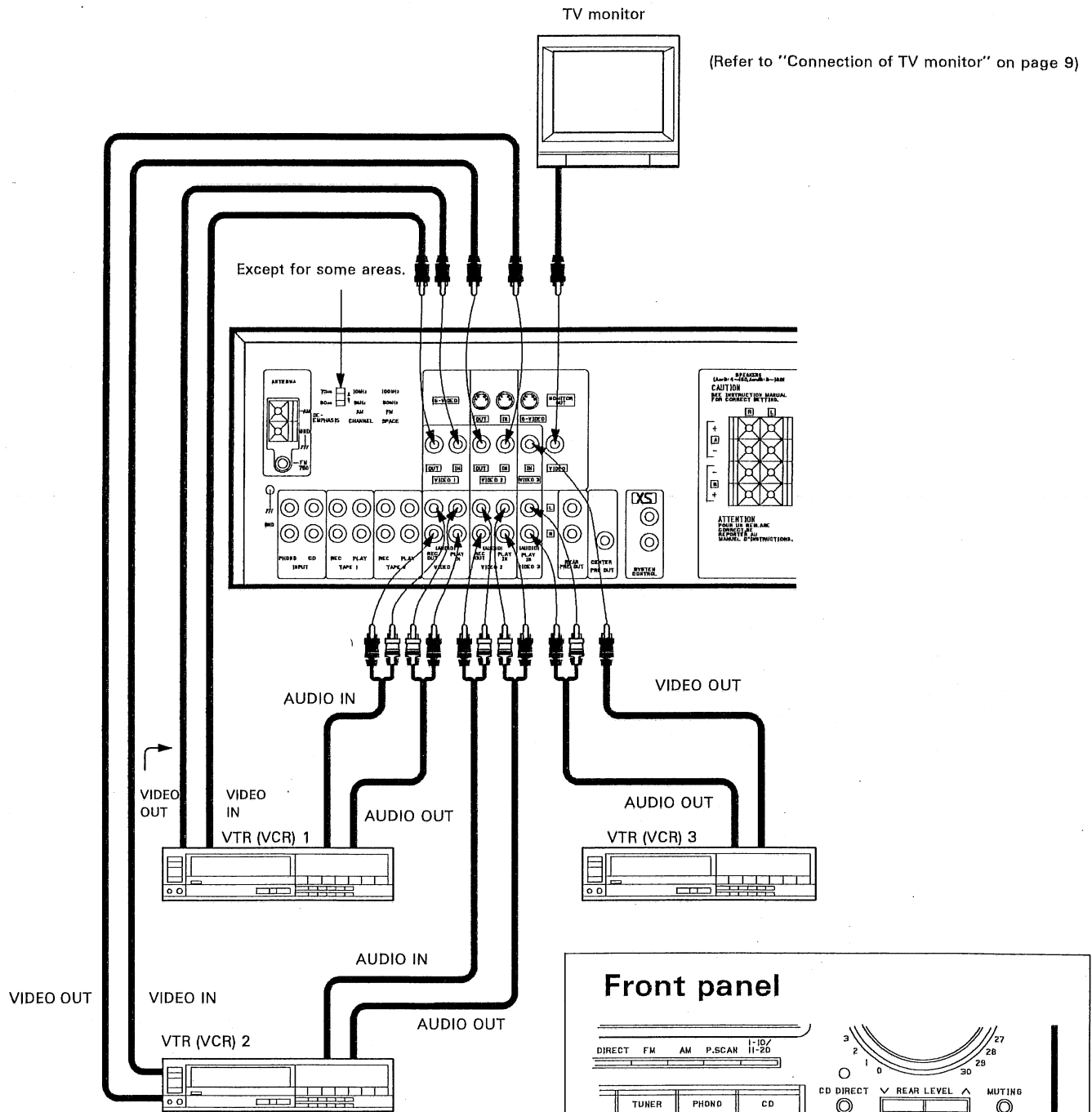

S-VIDEO Jacks:

In the S-Video (Y/C separated) signal transmission system, the regular video signal (composite signal) is separated into a signal identifying the brightness (Y: luminance) and a signal identifying the color (C: chroma) to be transmitted. Use of these jacks provides improved picture quality. When the S-VIDEO jacks are to be used, please read carefully the caution on page 27.

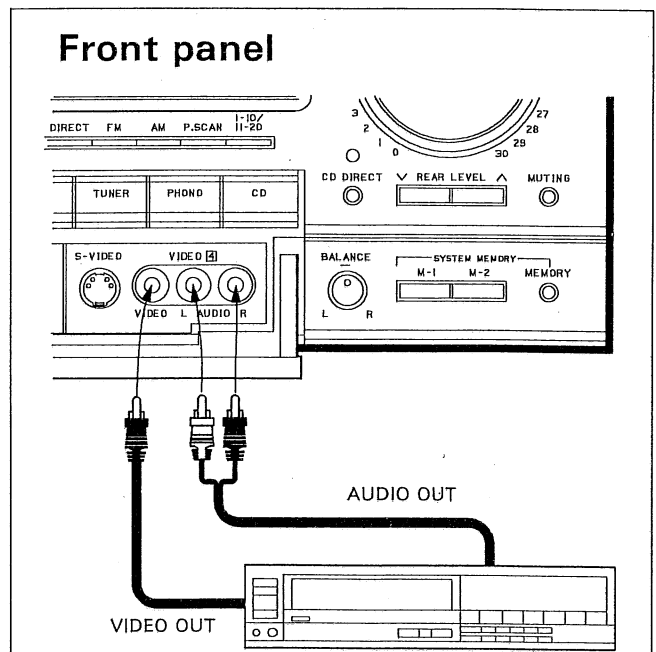

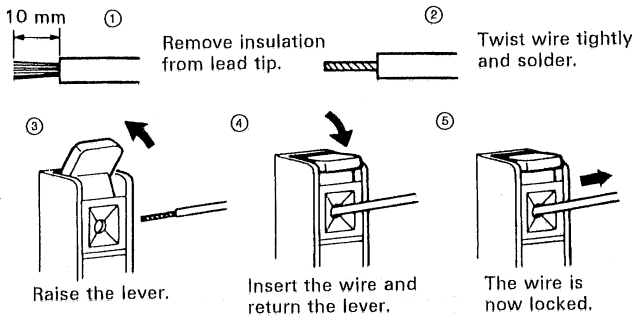

Speaker connections



Speaker lead connection

When using the speaker A or speaker B separately

Speaker impedance	Selector position
4Ω, 6Ω	A or B: LESS THAN 8Ω 
8Ω, 16Ω	8Ω OR MORE 

When using the speakers A and B simultaneously

Speaker impedance	Selector position
8Ω, 16Ω	A and B: 8Ω OR MORE 

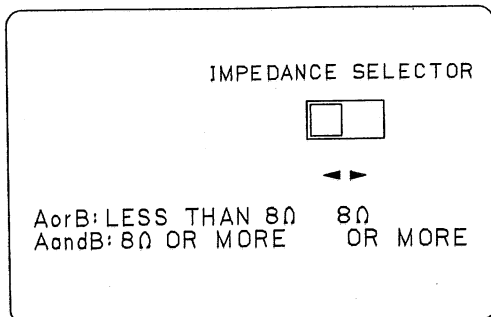

WARNING!

Particular attention must be given to making good electrical contact at the amplifier-output and speaker terminals.

Poor or loose connections can cause sparking or burning at the terminals because of the very high power that the amplifier can deliver. Follow these steps carefully.

■ Connecting the front speakers

Connect speakers rated at 4 ohm or more to the SPEAKERS terminals.

1. Connect the left speaker to the L speaker terminals on the rear of the receiver and the right speaker to the R terminals.
2. Connect each cable as shown in the illustration, taking care that the wires do not make contact with other terminals.

Notes:

1. Take care so as not to short the positive (+) and negative (-) speaker cords.
2. If the left and right speakers, or positive and negative cables, are connected the wrong way, the reproduced sound may be unclear, with ambiguous location of the musical instruments etc. To avoid this, pay attention to the left and right and positive and negative indications when connecting the speakers.

■ Setting the speaker IMPEDANCE SELECTOR

When connecting the speakers to the speaker terminals, set the IMPEDANCE SELECTOR switch according to the table on the left.

- When the IMPEDANCE SELECTOR switch is set to "8Ω OR MORE", it is impossible to use the A and B speakers at the same time.

Therefore, when using the speakers A and B simultaneously, be sure to set the IMPEDANCE SELECTOR switch to the "A and B: 8Ω OR MORE" position.

Notes:

1. During speaker system connection and operation of the speaker IMPEDANCE SELECTOR, set the POWER key to OFF.
2. Check that the connected lead wires of the speaker systems do not contact with other jacks or terminals.

Antenna connections

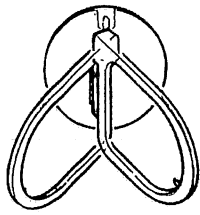

Vary the direction of the loop antenna.

AM loop antenna



Keep the speaker leads and AC cord away from the AM loop antenna.

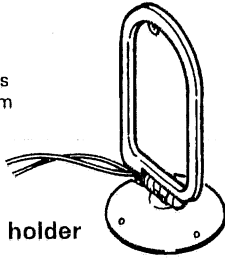

AM loop antenna holder

AM outdoor antenna

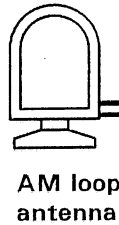

AM loop antenna

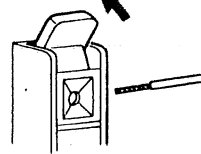

Press the lever.

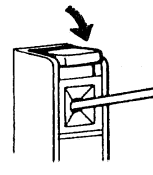

Insert the wire and return the lever.

FM indoor antenna

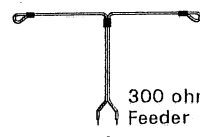

FM outdoor antenna

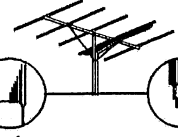

300 ohm Feeder

75 ohm Coaxial Cable

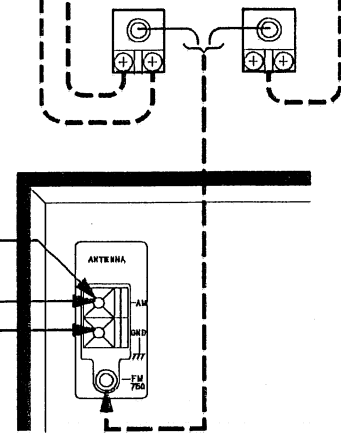

Connect the antenna leads as shown in the figure on the left.

AM antennas

AM loop antenna

Attach the AM loop antenna to the supplied loop antenna stand and place it on a shelf, etc., or install it on the rack or wall with screws. Rotate the AM loop antenna to the right or left for best reception.

Note:

Do not place the AM loop antenna directly on the unit. As this unit employs computing devices, placing the AM loop antenna on the unit may result in noise generation. Place the AM loop antenna away from the unit.

AM outdoor antenna

In steel buildings or at a great distance from the transmitter, it may be necessary to install an outside long wire antenna. The end of this wire should be stripped of insulation and connected to the AM terminal. At this time, keep the loop antenna connected.

FM antennas

FM indoor antenna

Connect the T-shaped indoor antenna (supplied) to the 75 ohm FM ANTENNA terminal with the 75 ohm/300 ohm antenna adaptor as shown in the Antenna connections diagram. Spread the two arms that form the top of the "T" horizontally and hold them against convenient wall surfaces.

Try several locations for best results with your favorite stations. Tape the antenna in place where the best compromise is found between listening results and appearance.

Connection of the 75 ohm/300 ohm antenna adaptor

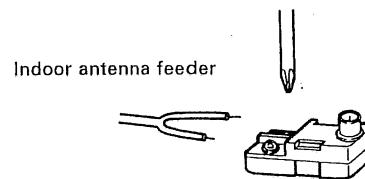

Loosen the screws with a screwdriver. Insert the antenna feeder under the screw heads and tighten the screws firmly.

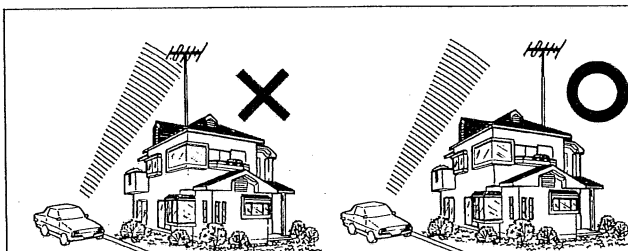

- To minimize auto-ignition noise, locate the antenna as far from heavy traffic as possible.
- Keep the feeder or coaxial cable as short as possible. Do not bundle or roll up excess cable.
- The antenna should be at least two meters (6.6 feet) from reinforced concrete walls or metal structures.

FM outdoor antenna setting

FM outdoor antenna

Be sure to use an outdoor FM antenna to receive good sound quality FM broadcasts with a minimum of noise. When connecting an outdoor antenna to the antenna terminals of this unit, use a 75 ohm/300 ohm antenna adaptor connected to the coaxial cable as illustrated. The 75 ohm/300 ohm antenna adaptor is supplied with this unit. Be sure to connect the coaxial cable to the adaptor as instructed below.

Note:

An FM outdoor antenna can be connected to the receiver with either a 75 ohm coaxial cable or a 300 ohm ribbon feeder. For proper connection, carefully read the instruction manual provided with outdoor antenna.

■ 75 ohm coaxial cable connection (Follow the order of numbers.)

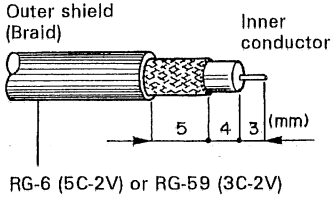
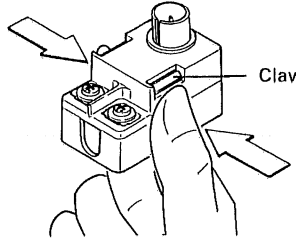
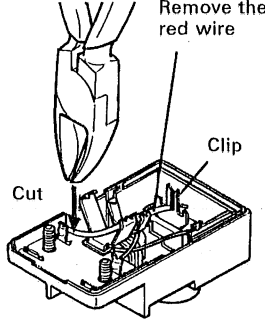
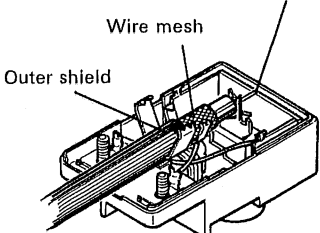
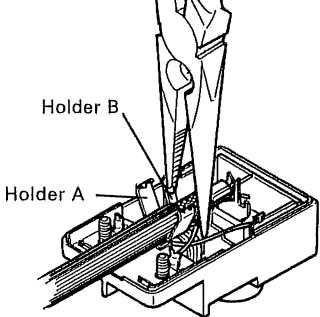
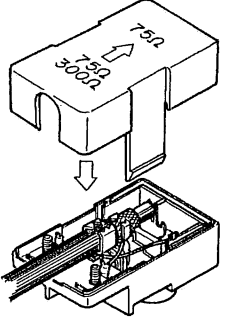
<p>① Arrange the coaxial cable as illustrated.</p> 	<p>② Open the 75 ohm/300 ohm antenna adaptor cover. Press the claws in the direction of the arrows with the fingers to release the lock and pull out the cover.</p> 	<p>③ Cut off the red wire and remove it from the clip.</p> 
<p>④ Connect the processed coaxial cable to 75 ohm/300 ohm antenna adaptor as shown below.</p> <p>Insert the inner conductor into the slot on the clip.</p> 	<p>⑤ Secure the holders A and B.</p> 	<p>⑥ Close the cover.</p> 

Area	Channel Space Frq.	FM DE-EMPHASIS
1. U.S.A. Canada and South American countries	FM: 100 kHz AM: 10 kHz	75 μs
2. Other countries	FM: 50 kHz AM: 9 kHz	50 μs

FM DE-EMPHASIS/CHANNEL SPACE table

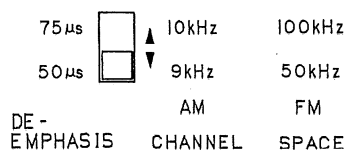

■ FM DE-EMPHASIS/CHANNEL SPACE switch (Except for some areas.)

The FM DE-EMPHASIS/CHANNEL SPACE switch on the rear panel is set to the correct setting that prevails in the area to which the unit is shipped. However, if the FM DE-EMPHASIS/CHANNEL SPACE setting is not matched to the area where the unit is to be used (for instance, if you move from area 1 to area 2 or vice versa), desired reception of AM/FM broadcasts cannot be expected. In this case, change the FM DE-EMPHASIS/CHANNEL SPACE setting in accordance with the area corresponding to the table on the left.

The FM DE-EMPHASIS setting is switched over at the same time.

Note:

When changing the setting of the FM DE-EMPHASIS/CHANNEL SPACE switch, first disconnect the power cord, then reset the channel space switch, connect the power cord again, and turn the power on.

System control operation

Connection

Using the system control cords provided with KENWOOD system component models, make connections as shown below.

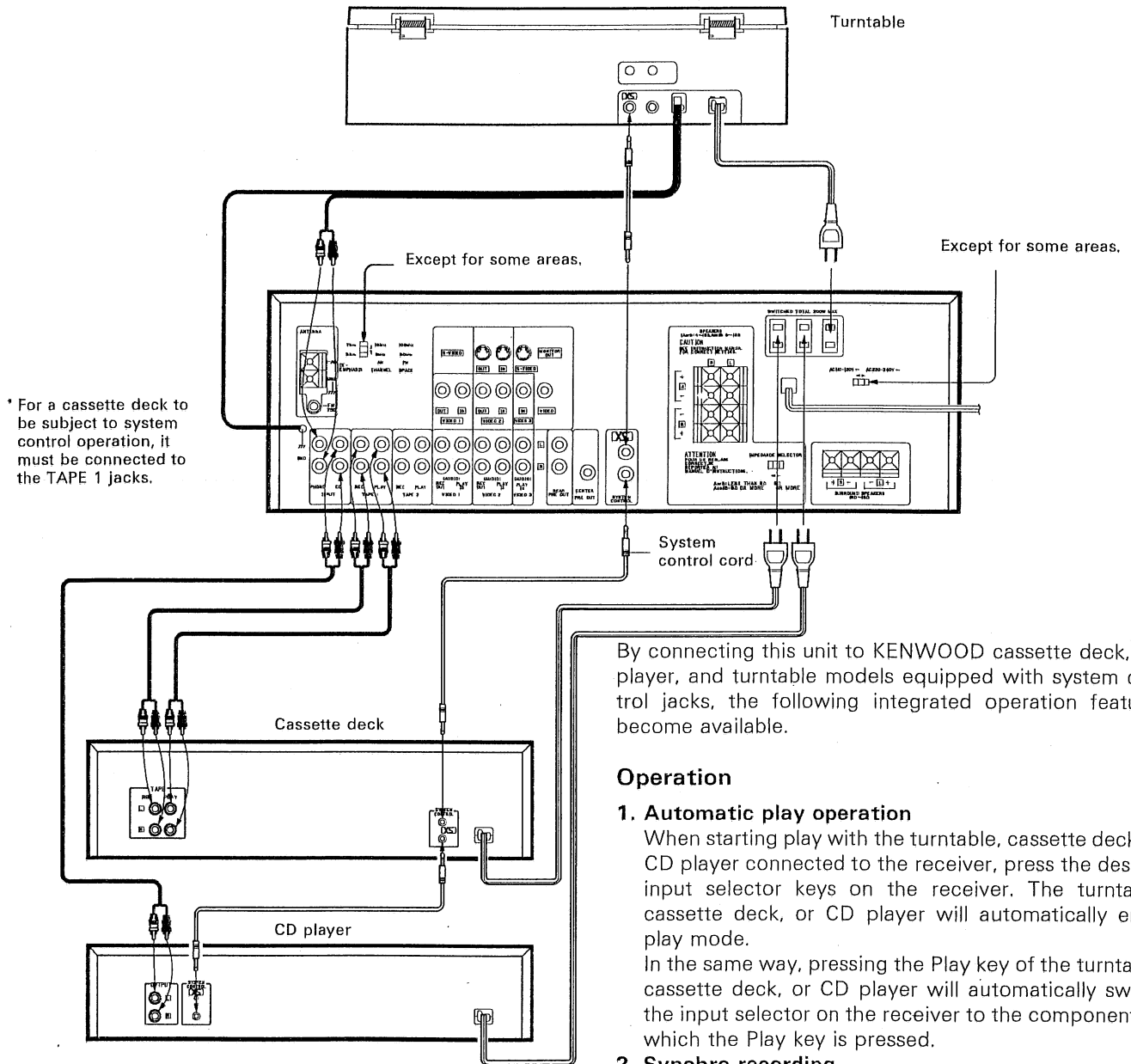

■ Connection of the audio cords and system control cord

Make sure that the audio cords are connected correctly right and left as in the figure.

If the system control cord and audio cords are not connected properly, the automatic system governing remote control and system functions will not operate.

(For connections of the audio cords, refer to the "System connections" diagram.)



By connecting this unit to KENWOOD cassette deck, CD player, and turntable models equipped with system control jacks, the following integrated operation features become available.

Operation

1. Automatic play operation

When starting play with the turntable, cassette deck, or CD player connected to the receiver, press the desired input selector keys on the receiver. The turntable, cassette deck, or CD player will automatically enter play mode.

In the same way, pressing the Play key of the turntable, cassette deck, or CD player will automatically switch the input selector on the receiver to the component on which the Play key is pressed.

2. Synchro recording

To record the sound from the CD player or turntable onto a tape with the cassette deck, press the CD or PHONO of the input selector keys and load a CD or record. Set the cassette deck to rec pause mode, then press the PLAY (START) key of the CD player or turntable. The cassette deck will start recording automatically, synchronized with the CD player or turntable starting play.

3. Remote control

The remote control unit provided with this unit, to which a KENWOOD system turntable, cassette deck, or CD player is connected, is equipped with related control keys. The related components can be controlled using these keys.

Note:

During recording with a cassette deck, the input selector on the receiver is fixed at the source from which the recording is made, by the system control circuit. At this time, pressing any of the

Controls and indicators

REMOTE SENSOR

Point the supplied remote control unit towards this sensor and operate.

SPEAKERS A and B keys

Selects the speaker system to be used for listening. The speaker system being used is shown on the display.

POWER key

Switches the power ON/STANDBY.

Power stand-by indicator

This indicator lights if the power cord is plugged into the AC outlet. It is lit to show that the POWER key on the front panel or the POWER key on the remote control unit can be activated.

PHONES jack

This jack accepts the standard stereo headphone plug. When you wish to listen through headphones alone, set the SPEAKERS keys (A and B) both to the OFF position.

EQUALIZER LEVEL control keys

Adjust these keys up and down to equalize the sound level of the indicated frequencies with in a range of ± 12 dB.

EQUALIZER FREQUENCY keys

These keys are used to select the equalizing frequency among 60 Hz, 150 Hz, 400 Hz, 1 kHz, 2.4 kHz, 6 kHz, and 15 kHz.

Equalizer preset MEMO. key

This key is used to store an equalizer pattern the PGM PRESET memory.

EQUALIZER key

Press this key to ON and the frequency characteristics of the sound will be modified by the graphic equalizer. In the DEFEAT position, the frequency characteristics remain unchanged.

Display section

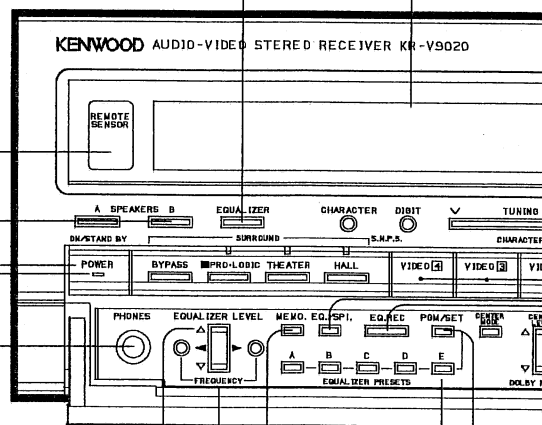

EQUALIZER PRESETS (A ~ E) keys

Use these keys to store equalizer patterns in memory or to recall them.

Equalizer preset mode key (PGM/SET)

Each time this key is pressed, the recall mode of the equalizer preset patterns alternates between PGM (user programmed patterns) and SET (factory preset patterns.)

How to open the door

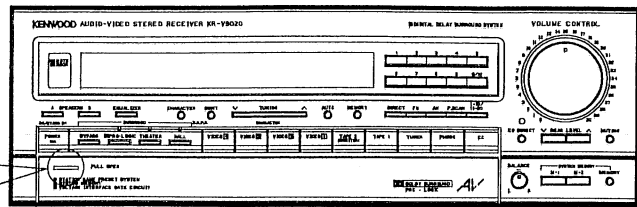
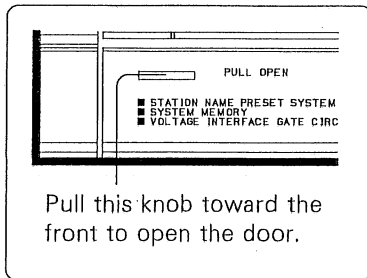

VOLUME CONTROL knob

This control adjusts the left- and right-channel volume levels simultaneously. Set it for the desired listening level.

Point indicator

This indicator blinks when the power is turned ON, muting is activated and when the volume control is adjusted with the remote control.

MUTING key

When the muting key is pressed, the point indicator in the VOLUME CONTROL knob blinks, and the overall listening sound level is reduced.

When the key is pressed again, the listening level is restored to same level as before.

REAR LEVEL control keys

Adjusts front/rear balancing when surround speakers are used. The control range is +20, -50 dB of the front speaker level.

BALANCE control knob

Adjust the left and right volume balance.

Input selector keys

Select the input source.

EQ./SPI key

Pressing this key alternates the display mode between EQ. (graphic equalizer) and SPI (spectrum peak indicator).

EQ. REC key

Used when recording a source to a tape deck through the graphic equalizer.

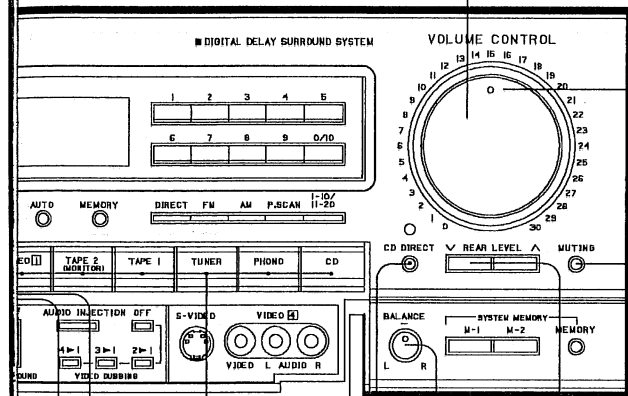

TUNING/CHARACTER keys

Used to change the frequency. Pressing the UP (▲) side will advance to a higher frequency and pressing the DOWN (▼) side will move to a lower frequency. In the station name input mode, this key is used to select the characters.

DIGIT key

In the station name input mode, pressing this key advances the column after a character is selected with the TUNING/CHARACTER UP/DOWN (▲/▼) key. When this operation is repeated four times the station name input mode is automatically released.

CHARACTER key

Press this key to activate the station name input mode.

SURROUND keys

Press any of these keys to select the required SURROUND mode. When the Surround sound is not required, press the BYPASS key to set to the BYPASS mode.

DELAY TIME keys

With the SURROUND mode activated, select the required delay time using these keys.

Display section

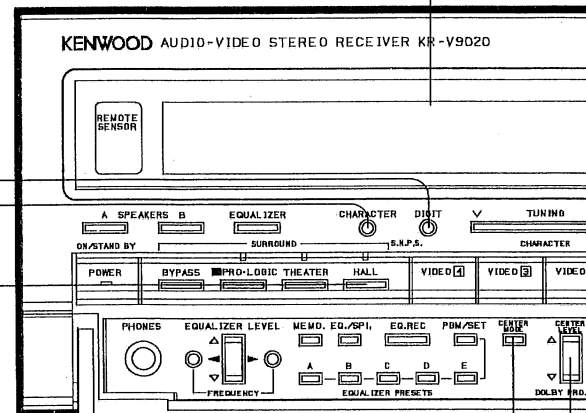

CENTER MODE key

This key is used to select the CENTER MODE for the DOLBY PRO-LOGIC SURROUND mode. Each time this key is pressed, the CENTER MODE changes in the following order:



CENTER LEVEL keys

These keys are used to adjust the CENTER LEVEL in the NORMAL or WIDE mode of DOLBY PRO-LOGIC function. The output level of the center speaker can be increased or decreased between +20 dB and -50 dB around the front speaker level.

AUTO key

Press this key to select the tuning mode between AUTO or MANUAL. In MANUAL mode, FM stereo broadcasts are received in monaural.

MEMORY key

When this key is pressed, the MEMORY indicator lights and the unit stands by for entry of a preset station number.

Numeric (1 ~ 0/10) keys

Use these keys to:

- 1) input directly the digits of frequencies, or
- 2) store and recall frequencies in the preset channels.

DIRECT key

Used to tune to a station directly. Input the desired frequency with the numeric keys after pressing the DIRECT key.

Band selector (AM, FM) keys

Press to select the receiving band.

Preset function (1-10/11-20) key

Used to select the 1-10 or 11-20 preset channel setting. In either FM or AM mode, 20 stations can be preset at random as each setting ("1-10" or "11-20") can contain 10 preset stations. Indicator "1-10" lights when the "1-10" setting is used, and indicator "11-20" lights when the "11-20" setting is used.

PRESET SCAN key

Use this key for preset channel scanning.

When a frequency stored in the preset memory is being received, pressing this key shifts reception to the next frequency stored in the preset memory.

System MEMORY key

This key is used to store the current playing condition in memory.

SYSTEM MEMORY channel keys (M-1/M-2)

Two memory groups can be used with the System Memory feature.

VIDEO DUBBING keys

Press any of these keys when dubbing the video program source regardless of the input source selected by the input selector key.

AUDIO INJECTION key

Press this key ON when it is necessary to replace the sound of VCR with that of an AUDIO source during video dubbing.

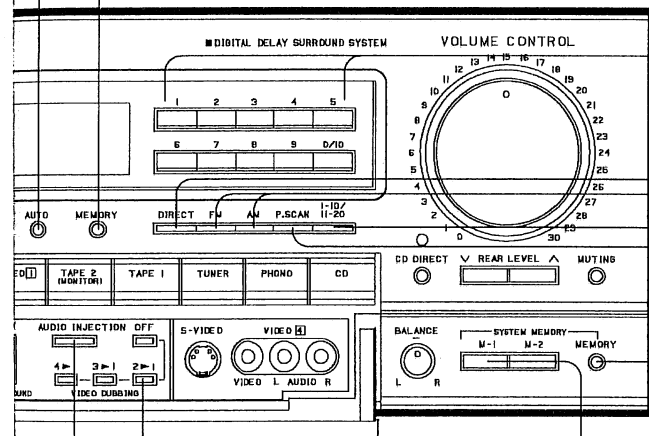

Operating instructions

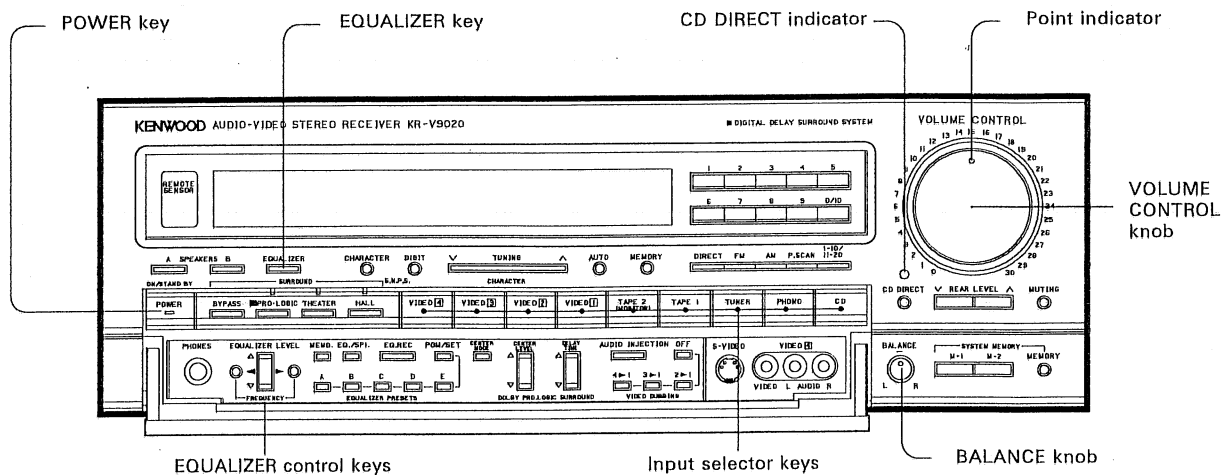

STAND BY mode of POWER key

When the power cord of this system is plugged into an AC outlet, the STAND BY indicator lights up regardless of the ON/OFF setting of the POWER key. This indicates that a small amount of current is being supplied to the unit to back up the memory contents. This mode is referred to as the Stand By mode. While the STAND BY indicator is lit, the power of the system can be switched ON/OFF from the remote control unit.

To mute the sound temporarily Press the MUTE key.

- The point indicator blinks, and the output is muted.
- When the MUTE key is pressed again, the muting is canceled, the point indicator lights steadily and the previous output level is resumed. The mute mode can also be released by changing the output level using the remote control unit.
- The point indicator also blinks (for approx. 4 seconds) when the muting functions is engaged immediately after the power is turned ON.

Basic operation

1. Press the POWER key to ON.
 - The display lights and the unit becomes operative.
 - Pressing the key again switches the power OFF.
2. Press one of the input selector keys to select the input source to be played.
 - If a System Control cord has been connected to the selected source component, it starts play automatically due the Automatic Play operation feature.
 - With the Automatic Play operation feature, when one of the source components is started to be played, the corresponding input selector is automatically switched for the source.
 - The selected input source is shown on the display.
3. If automatic play operation using the System Control cords has not been set, start playing the source component selected.
4. Adjust the output level with the VOLUME CONTROL knob.
 - When one of the VOLUME CONTROL keys on the remote control unit is pressed, the point indicator blinks and the VOLUME CONTROL knob is rotated.
5. Adjust the balance of the left and right output levels with the BALANCE knob.
6. Adjust the tone referring to the description in the "Graphic equalizer" section.
 - The graphic equalizer effect can be switched ON/DEFEAT by pressing the EQUALIZER key.

Notes:

1. The CD DIRECT key should usually be set to OFF (with the indicator not lit).
2. When the TAPE-2 selector switch is set to ON, the input source selected with the input selector keys cannot be heard from the speakers. To listen to a source other than tape deck 2, be sure to set the TAPE-2 selector key to OFF.

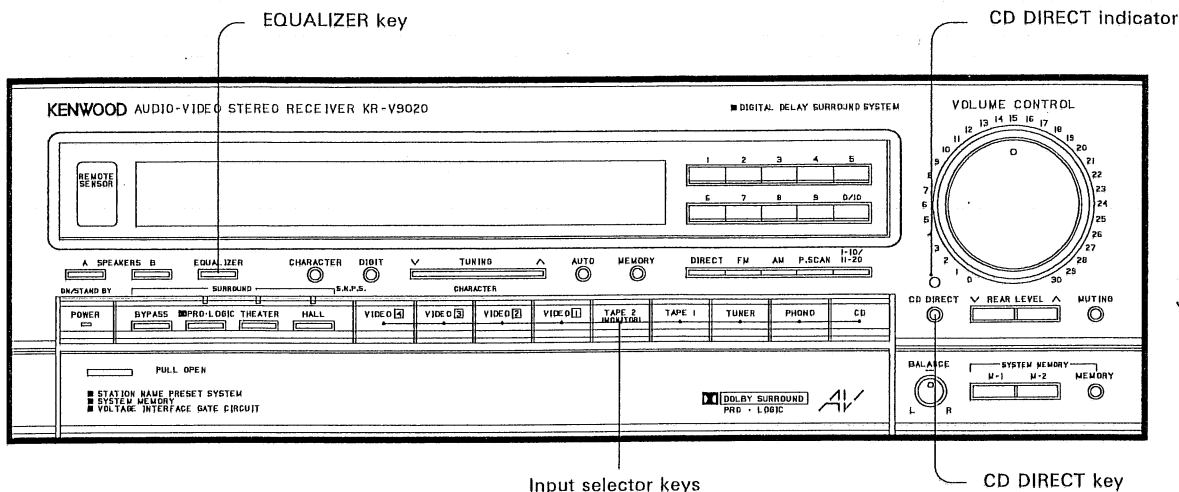

■ Operations using CD DIRECT key

To enjoy more pure and high-quality sound of Compact Discs:

1. Press the CD key
2. Press the CD DIRECT key.

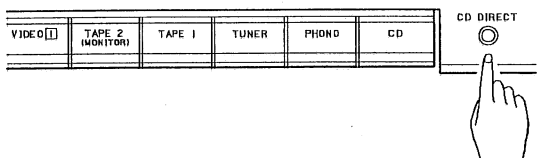

3. Play the CD player.
 - The CD DIRECT key is given priority over the setting of the input selector keys.
 - The graphic equalizer cannot be used while the CD DIRECT key is ON.
 - To cancel the CD DIRECT input, press the CD DIRECT key again or press one of the input selector keys (except CD and TAPE 2 keys). The input will be switched to the source indicated on the display.

Note: When the CD DIRECT key is pressed in one of the Surround modes (PRO-LOGIC, THEATER or HALL SURROUND), the unit enters the Bypass mode.

■ To record an input source

1. Select the source to be recorded with the input selector keys.
2. Play the source.
3. Set tape deck 1 and/or tape deck 2 to record mode.

Note: When a tape deck is connected to this unit with a System Control cord, all of the input selector keys are disabled during recording and do not function until recording is finished. This will prevent the recording from being interrupted.

■ Tape dubbing

Tape recordings may be duplicated (dubbed) easily using two tape decks connected to the TAPE 1 and 2 jacks.

For example:
(TAPE 1 to 2):

1. Connect two tape decks to the TAPE 1 and TAPE 2 jacks.
2. Press the TAPE 1 key.
3. Play back the recorded tape and adjust the recording levels before starting tape dubbing.

(TAPE 2 to 1):

1. Press the TAPE 2 key.
2. Press a key other than TAPE 1 of the input selector keys such as CD.
3. Play back the recorded tape and adjust the recording levels before starting tape dubbing.
4. Do not press the TAPE 1 key during recording with tape deck 1.

Note: Adjust recording levels on the deck that is making the copy using that deck's operating controls.

Listening to broadcasts

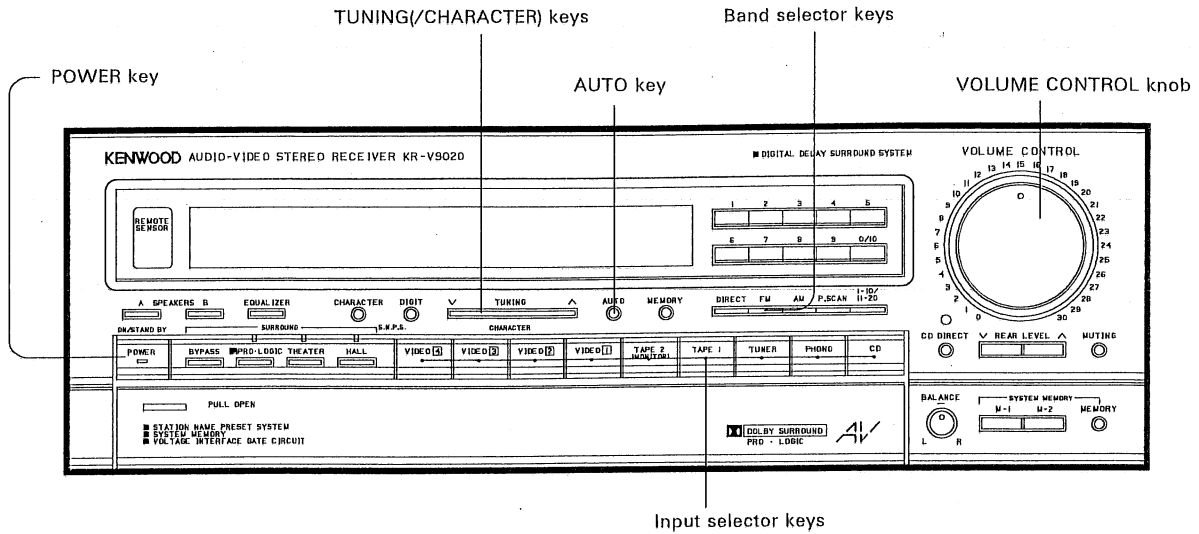

■ To listen to radio broadcasts

1. Press the POWER key to ON.
2. Press the TUNER input selector key.
3. Press the AM or FM band selector key.
4. Tune in the desired broadcasting station according to the instructions in the "Tuning methods" section below.
5. When the desired station is received, adjust the volume with the VOLUME CONTROL knob.

■ Tuning methods

Auto tuning

When the TUNING key is pressed, broadcast frequencies are scanned automatically in the upward or downward direction until a station is located and tuned in. The stereo/monaural FM reception mode is set automatically according to the station.

1. Press the AUTO key so that the AUTO indicator lights.
2. Press the UP (Δ) or DOWN (∇) segment of the TUNING key.
 - Pressing the UP (Δ) segment scans broadcast frequencies by varying the displayed frequencies in the upward direction, and pressing the DOWN (∇) segment scans by varying the frequencies in the downward direction.
 - When a broadcasting station is received, the frequency display freezes and indicates the frequency of the received station.
3. If the received station is not the desired station, press the same segment of the TUNING key again.
 - Repeat this until the desired station is received.

Manual tuning

Stations with weak signal strength cannot be received by auto tuning. In such cases, tune in the desired station by manual tuning. The station will be received in monaural mode (monaural mode is resistant to noise).

1. Press the AUTO key so that the AUTO indicator is off.
2. Press the UP (Δ) or DOWN (∇) segment of the TUNING key.
 - Every time the TUNING key is pressed, the displayed frequency varies by one step in the direction indicated by the pressed segment.
 - Holding the TUNING key depressed varies the displayed frequency continuously.
3. When the frequency of the desired station is tuned in, release the TUNING key.
 - Noise may be heard if the tuned frequency is not precisely the same as the frequency of the station. In such cases, press the UP (Δ) or DOWN (∇) segment of the TUNING key to adjust the tuning precisely.

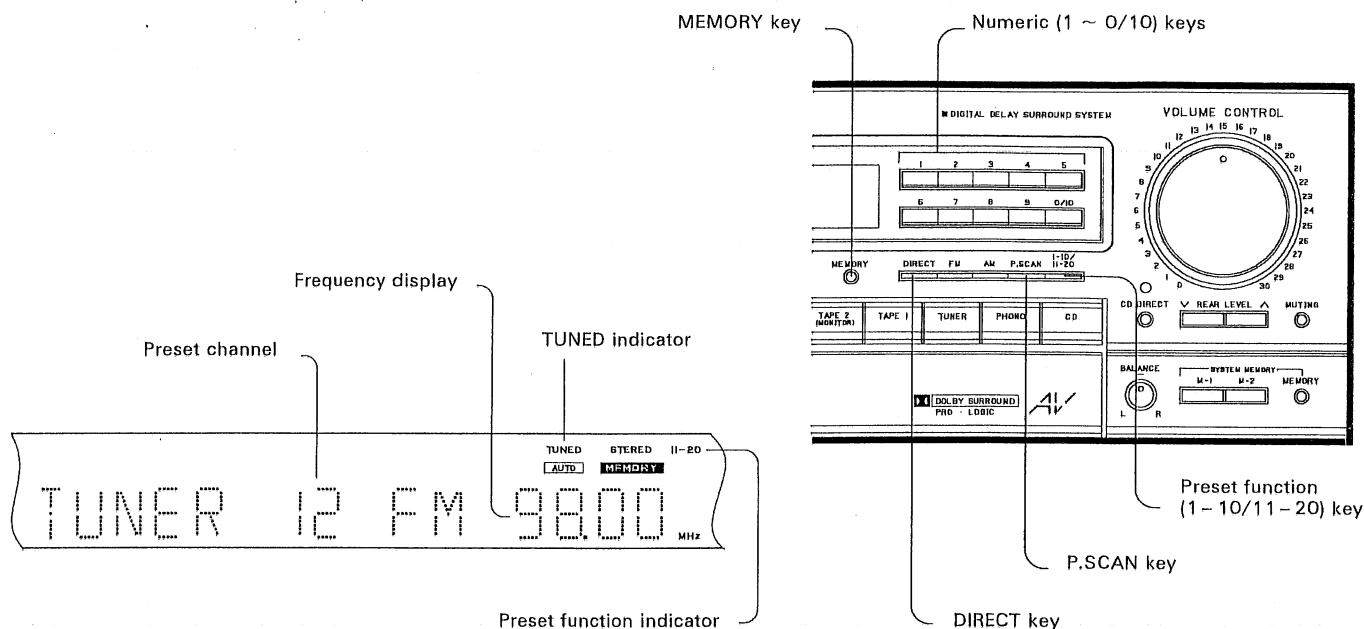

Direct tuning

This method allows the desired frequency to be entered directly using the numeric keys, without using the TUNING key.

1. Press the DIRECT key.
2. Enter the frequency of the desired station with the numeric keys.
 - When all of the digits of the frequency have been entered, the station is automatically received.
 - If the entered frequency is not in the receivable frequency range, message "CAN NOT TUNE" is displayed for 5 seconds, and the last station received is received again.

■ Preset tuning

By storing the frequencies of broadcasting stations in the preset channels according to the instructions in the "To preset station frequencies" section, any of the preset stations can be received by one-touch operation.

1. Press the preset function key to select "1-10" or "11-20".
2. Press the numeric key corresponding to the preset channel of the desired station.
 - The display shows the frequency of that station, and the station is received.

■ Preset Scan

This function allows the preset stations stored in the preset channels to be received in sequence for 5 seconds each.

1. Press the P.SCAN key.
 - The frequency of each preset station is received for 5 seconds in sequence. A preset channel in which no station has been preset is skipped, and the scan operation moves to the next preset channel.
2. To stop Preset Scan, press the P.SCAN key again.
 - The preset station being received when the key is pressed is received continuously.

■ To preset station frequencies

1. Press the band selector key for the desired band (FM or AM).
2. Tune in the desired station following the instructions in the "Tuning methods" section.
3. Press the preset function key to select the 1-10 or 11-20 preset channel range.
4. Press the MEMORY key.
 - The MEMORY indicator on the display lights.
5. Within 5 seconds after pressing the MEMORY key, press the numeric key (1 to 0/10) corresponding to the preset channel in which the frequency is to be stored.
 - If a frequency has already been stored under the selected preset channel, the previously-stored frequency will be replaced by the new frequency.
6. Preset all desired frequencies by repeating steps 1 to 5 above.
 - When preset channels 1 to 10 have become full, press the preset function (1-10/11-20) key again to select the 11-20 range.

Listening to broadcasts

This unit allows both the frequencies and the names of broadcasting stations to be preset. When a station is recalled by preset tuning, the display shows both the frequency and the name of the station. (S.N.P.S.)

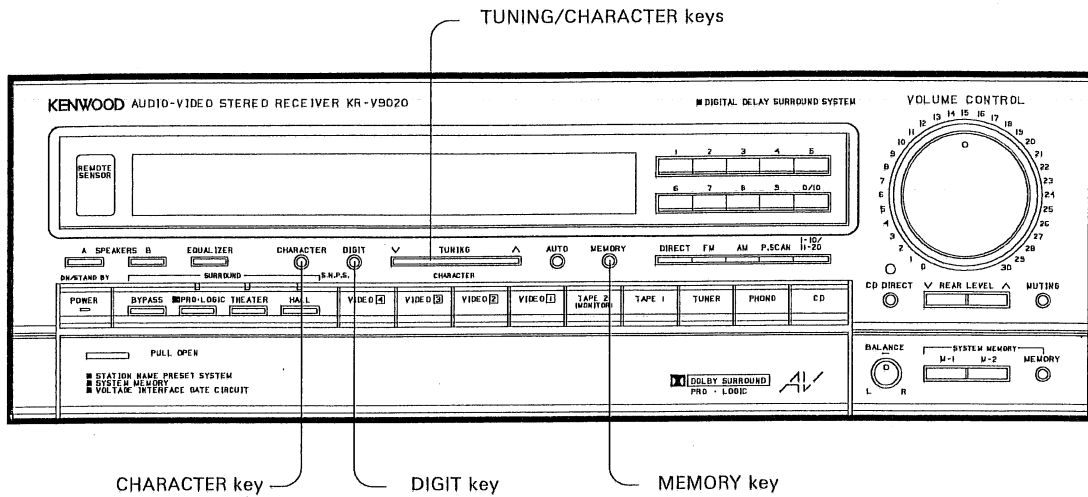

Selection of display characters with the TUNING/CHARACTER key

Every time the UP (▲) segment of the TUNING/CHARACTER key is pressed, the displayed character is varied in the following order:

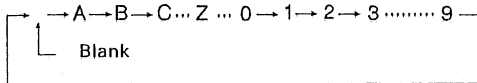

(Pressing the DOWN (▼) segment varies the displayed character in the reverse order.)

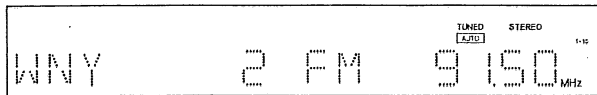
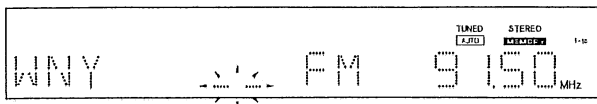
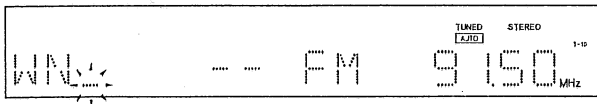
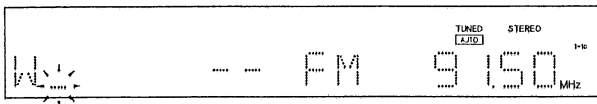
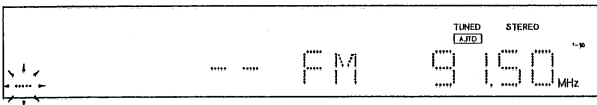

To preset station names and frequencies

Example 1: To preset the 91.50 MHz FM broadcast frequency and its station name "WNY" in preset channel number 2.

1. Tune to 91.50 MHz FM.
2. Press the CHARACTER key.
3. Press the TUNING/CHARACTER key to select "W".
4. Press the DIGIT key to set the character and move to the next location.
5. Press the TUNING/CHARACTER key to select "N".
6. Press the DIGIT key.
7. Press the TUNING/CHARACTER key to select "Y".
8. Since the fourth column should be left blank, press the DIGIT key twice or press the CHARACTER key.
9. Press the MEMORY key.
10. Press numeric key "2" to select preset channel 2.

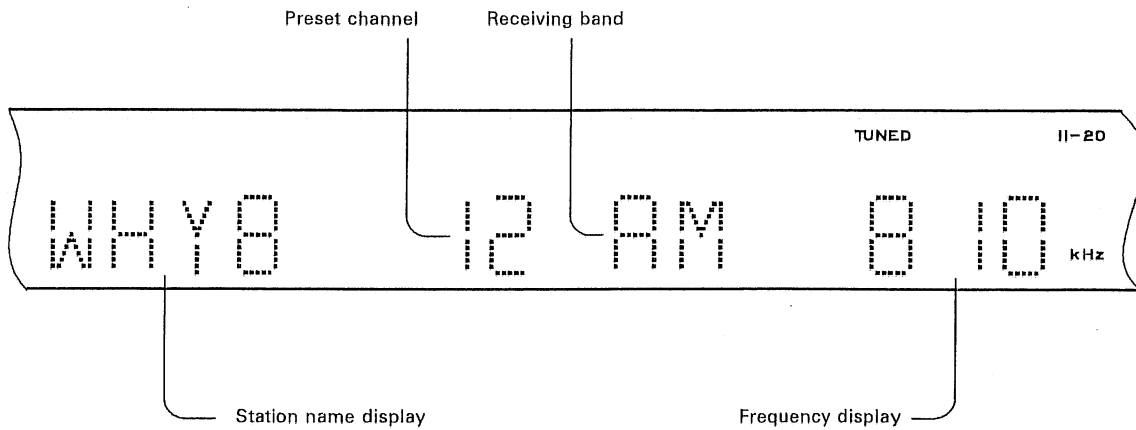

■ To change a preset station name

Example 2: To change the name of the 810 kHz AM broadcasting station stored in preset channel number 12 from "WHY8" to "WGY"

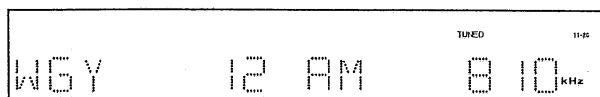
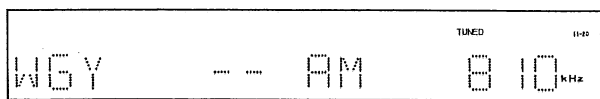
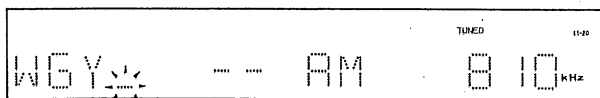
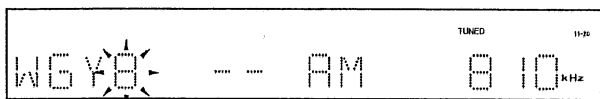
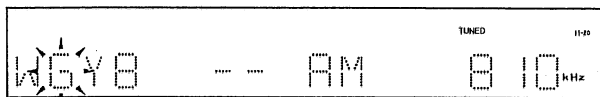
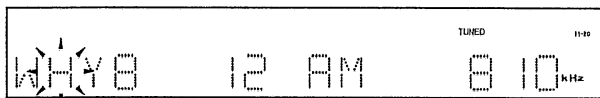
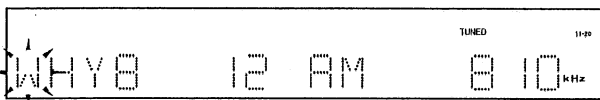
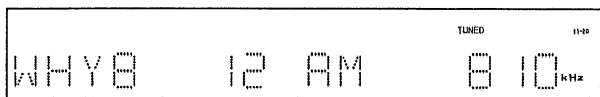

1. Recall preset channel number 12 with the preset function key and numeric key "2" according to the instructions in the "Preset tuning" section.
2. Press the CHARACTER key.
3. Press the DIGIT key to move to the first character location to be changed.
4. Press the TUNING/CHARACTER key to select "G".
5. Press the DIGIT key twice.
6. Press the TUNING/CHARACTER key to select a blank.
7. Press the DIGIT key or the CHARACTER key.
8. Press the MEMORY key.
9. Press numeric key "2" to select preset channel number 12.

Graphic equalizer operation

This unit incorporates a high-performance 7-band stereo graphic equalizer. The graphic equalizer is equipped with memory for storing equalizer patterns created by the user, as well as for storing factory-preset patterns which can be recalled easily to provide equalizing effects suitable for various types of music.

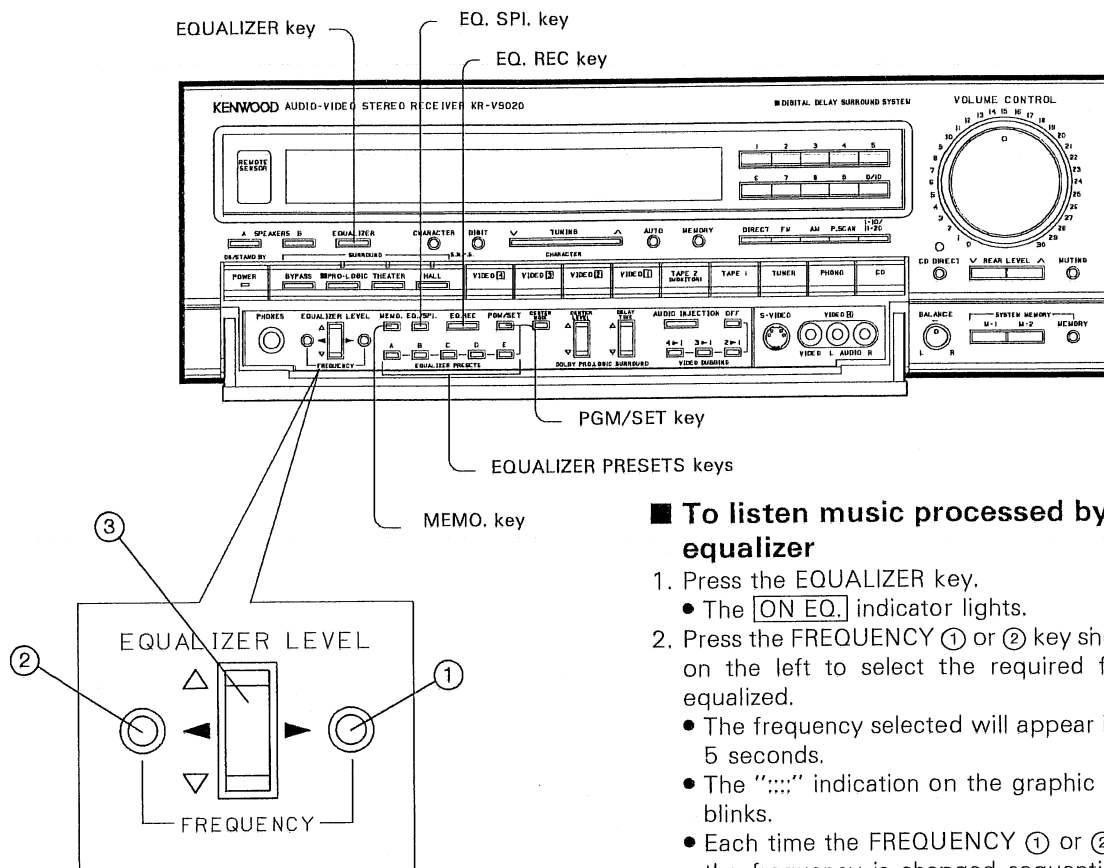

EQUALIZER control keys

(Press the FREQUENCY ①, ② to select the frequency to be equalized.)

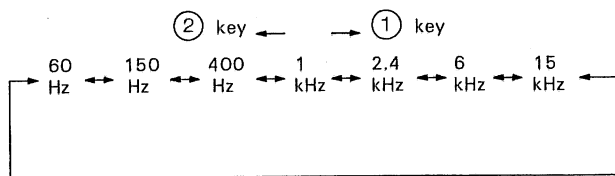

Sequential change of equalizer frequency

■ To listen music processed by the graphic equalizer

- Press the EQUALIZER key.
 - The **ON EQ.** indicator lights.
- Press the FREQUENCY ① or ② key shown in the figure on the left to select the required frequency to be equalized.
 - The frequency selected will appear in the display for 5 seconds.
 - The "::::" indication on the graphic equalizer display blinks.
 - Each time the FREQUENCY ① or ② key is pressed, the frequency is changed sequentially as shown in the table on the left.
- Press the EQUALIZER LEVEL key ③ shown in the figure on the left to set to the required level for the selected frequency.
 - Pressing the EQUALIZER LEVEL Δ key increases the level of the selected frequency in +2 dB steps up to +12 dB.
 - Pressing the EQUALIZER LEVEL ∇ key decreases the level of the selected frequency in -2 dB steps up to -12 dB.
- Repeat the operation in steps 2 and 3 to set the equalizer pattern as desired.
 - It is also possible to select a preset equalizer pattern by pressing one of the EQUALIZER PRESETS keys (A ~ E)
- To defeat the equalizer effect, press the EQUALIZER key again.
 - The **EQ. DEFEAT** indicator lights.

■ Equalizer recording

With this unit, sound processed by the graphic equalizer can be recorded through the TAPE-1 output.

- Press the EQ.REC key.
 - The **EQ. REC** indicator lights.
- Start recording on the TAPE 1 tape deck.
 - When the EQ.REC key is pressed again, the **EQ. REC** indicator goes off and normal (unprocessed) sound is output.

Note: _____

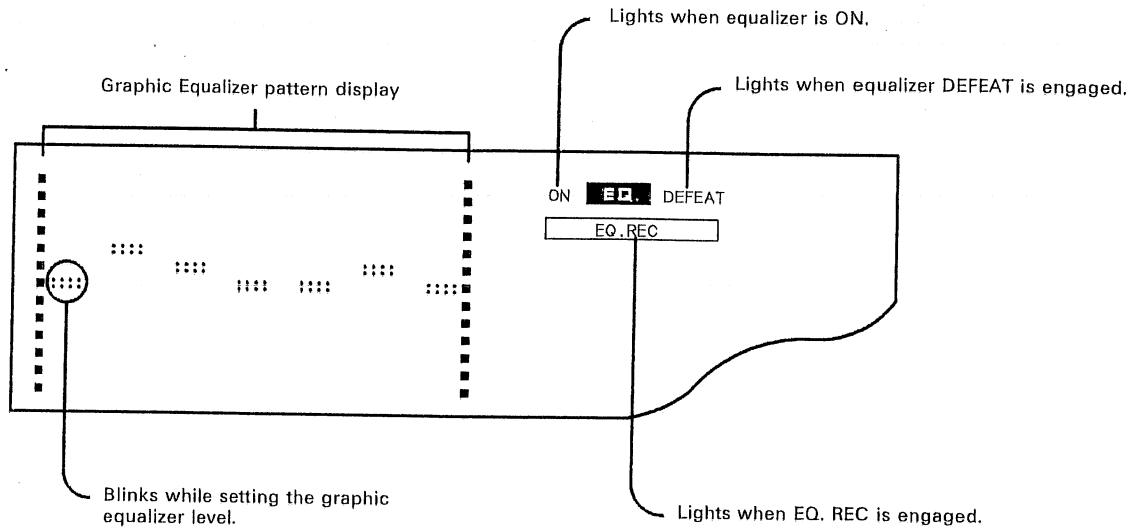

■ Preset equalizer memory and its applications

Five equalizer patterns are permanently preset in the memory of this unit for easy recalling at any time.

1. Press the PGM/SET key to SET.
 - The "EQ. SET-□" indication appears in the display for 5 seconds.
2. Press one of the EQUALIZER PRESETS keys (A ~ E).
 - The recalled equalizer pattern is displayed.

Characteristics of the "SET" preset patterns

- A: For solid and punchy sound.
- B: For effective reproduction of dynamic movie sound.
- C: For easy-listening background music.
- D: For music sound reproduction with a live, "being-there" feeling.
- E: For realistically reproducing vocal music.

■ To store user-programmed equalizer patterns in memory

Up to five equalizer patterns created by the user can be stored in memory for recalling at any time.

1. Set the desired pattern with the equalizer control keys.
2. Press the PGM/SET key to PGM.
 - The "EQ. PGM-□" indication appears in the display for 5 seconds.
3. Press the MEMO. key.
 - The [MEMORY] indicator lights.
 - The "EQ. PGM-✱" indication appears in the display.
4. Within 5 seconds, press any of the EQUALIZER PRESETS keys A to E.

■ To recall user-programmed equalizer patterns from memory

1. Press the PGM/SET key to PGM.
 - The "EQ. PGM-□" indication appears in the display for 5 seconds.
2. Press one of the EQUALIZER PRESETS keys (A ~ E).
 - The recalled equalizer pattern is displayed.

One of characters A to E is displayed inside "□".

■ To switch the display contents

Spectrum analyzer display

Press the EQ./SPI. key to SPI.

The spectrum analyzer display shows the frequency level distribution of the signal being played. The spectrum analyzer display is useful to refer to when setting equalizer patterns.

Graphic equalizer display

Press the EQ./SPI. key to EQ.

The frequencies are divided into seven frequency bands, and the level of each band can be set while observing the shape of the equalizer pattern.

- Even when the spectrum analyzer display is selected, the graphic equalizer is displayed for about 5 seconds in the following cases.

- ① When the POWER key is set to ON.
- ② When any of the equalizer control keys is pressed.
- ③ When the MEMORY key is pressed.
- ④ When any of the A to E keys is pressed.

After about 5 seconds, the spectrum analyzer display is resumed.

Playing video sources

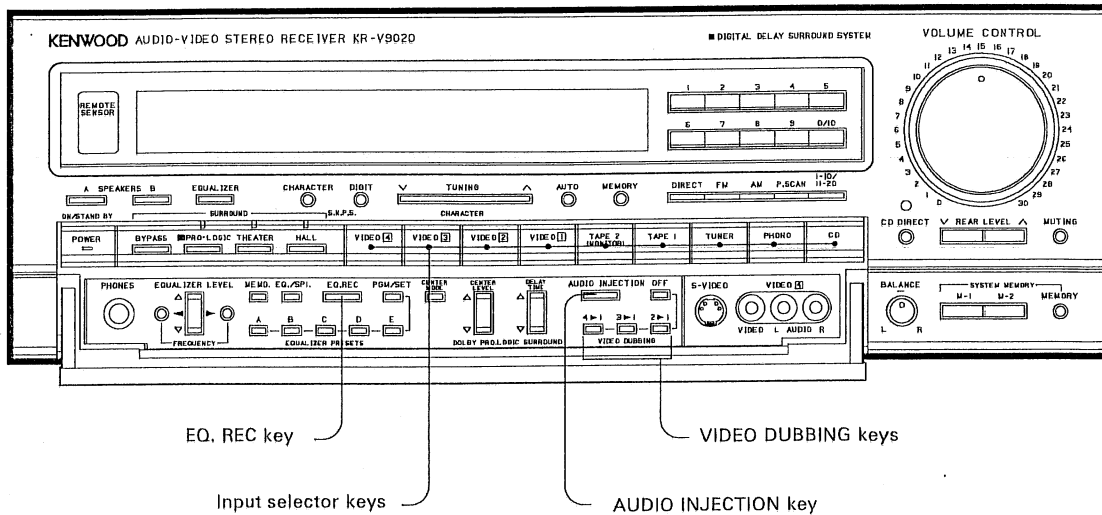

■ To play a video source

(For Surround playback, refer to "Surround effects" on page 28.)

1. Press the POWER key to ON.
2. Switch on the power of the monitor TV connected to the MONITOR OUT jack.
3. Select the playback source with the input selector keys.
4. Play the video component.
5. The video is reproduced on the monitor TV, and the audio is reproduced through the speakers.

■ Dubbing between two VCRs

Video dubbing can be performed while listening to any desired source.

With this receiver, through dubbing from VCR 2, VCR 3 or VCR 4 to VCR 1 is possible.

To dub through from VCR 2 (or VCR 3 or VCR 4) to VCR1:

1. Press the VIDEO DUBBING **2 → 1** (or **3 → 1** or **4 → 1**) key.
 - The **THROUGH DUB. 2 → 1** (or **THROUGH DUB. 3 → 1** or **THROUGH DUB. 4 → 1**) indicator lights.
2. Set the VCR 1 to the recording mode.
3. Set the VCR 2 (or VCR 3 or VCR 4) to the playback mode.

To stop through dubbing or after dubbing is finished:

Press the VIDEO DUBBING **OFF** key.

- When through dubbing is not required, be sure to set to the OFF mode.

Note:

The audio injection does not function during through dubbing mode.

■ Audio injection

During video dubbing, the sound from the VCR can be replaced with sound from any desired audio source without affecting the picture.

In addition, the graphic equalizer effect can be applied to the recorded audio source.

1. Press the AUDIO INJECTION key so that the **AUDIO INJ.** indicator lights.
2. Select the desired audio source for Audio injection with the input selector keys.
3. When equalizer compensation is required when recording a desired audio source with audio injection ON, press the EQ. REC key.
 - The **EQ. REC** indicator lights up.
 - Set the equalizer controls as desired.
4. Operate each VCR for dubbing.

Note:

The audio injection does not function during through dubbing mode.

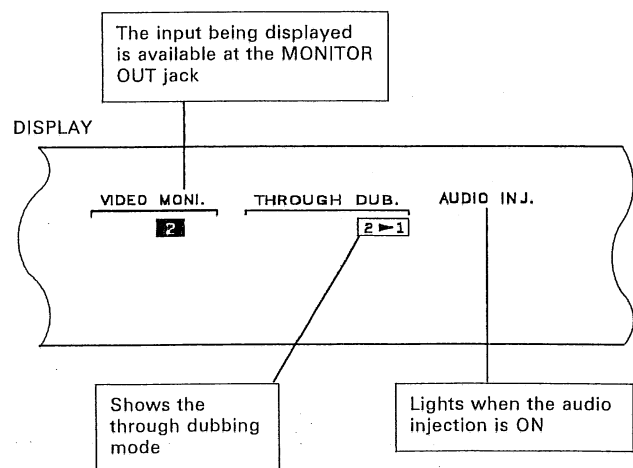

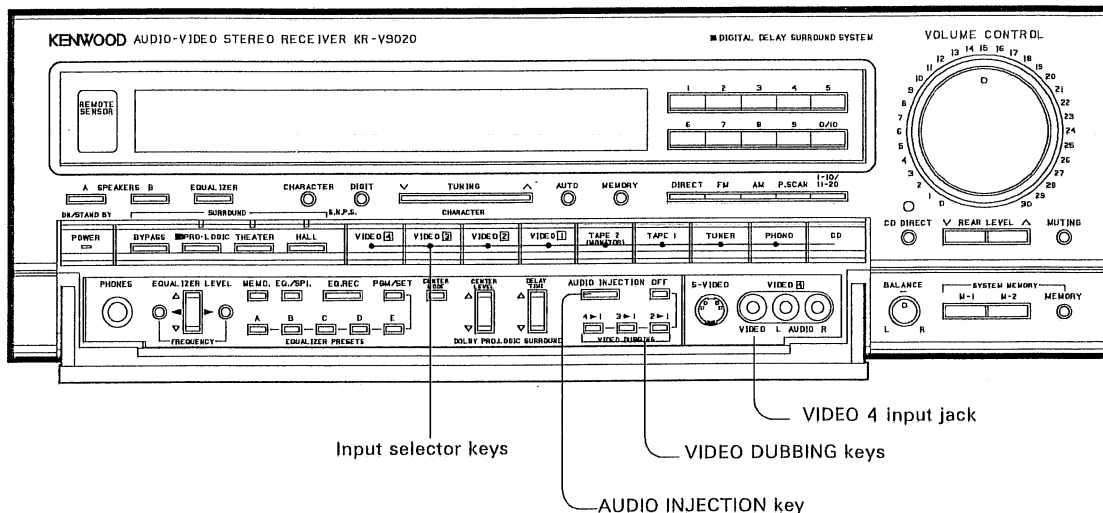

Example of video dubbing operation

■ To record with VCR1

When audio injection is not required (Through dubbing):

1. Press the required VIDEO DUBBING key ($2 \blacktriangleright 1$, $3 \blacktriangleright 1$ or $4 \blacktriangleright 1$).
2. Set the VCR 1 to the recording mode.
3. Set the playback VCR (VCR 2, VCR 3 or VCR 4) to the playback mode.

When audio injection is required:

1. Press the VIDEO DUBBING **OFF** key.
2. Select the playback VCR with the input selector keys.
3. Set the AUDIO INJECTION to ON.
4. Select the audio source to be injected using the input selector keys.
5. Set the VCR 1 to the recording mode.
6. Play the required VCR and audio source component.

■ To record with VCR 2

1. Press the VIDEO DUBBING **OFF** key.
2. Select the playback VCR with the input selector.
(When Audio Injection is required)
- (3) Set the AUDIO INJECTION to ON.
- (4) Select the audio source used for audio injection with the input selector.
3. Set the VCR 2 to the recording mode.
4. Start playing the playback VCR.
(When the audio injection is ON, also play the audio source component.)

Note:

The rear panel video output jacks do not output a video signal in the following cases:

Signal input jack	Jacks with no output	
S-VIDEO IN jack of "VIDEO 2"	VIDEO OUT jacks of each "VIDEO"	VIDEO jack of "MONITOR OUT"
VIDEO IN jack of each "VIDEO"	S-VIDEO OUT jack of "VIDEO 2"	S-VIDEO jack of "MONITOR OUT"

- Since the S-VIDEO and VIDEO circuits are independent of each other, dubbing/playback from an S-VIDEO jack to a VIDEO jack or from a VIDEO jack to an S-VIDEO jack is impossible. However, dubbing/playback from the S-VIDEO jack of "VIDEO 4" to each VIDEO jack is possible. The relationships between the various video terminals are shown in the table on the left.
- When a video component or TV monitor having an S-VIDEO jack is used, be sure to connect both the S-VIDEO jack and the (composite) VIDEO jack to the S-VIDEO and VIDEO jacks of this unit.

Surround effects

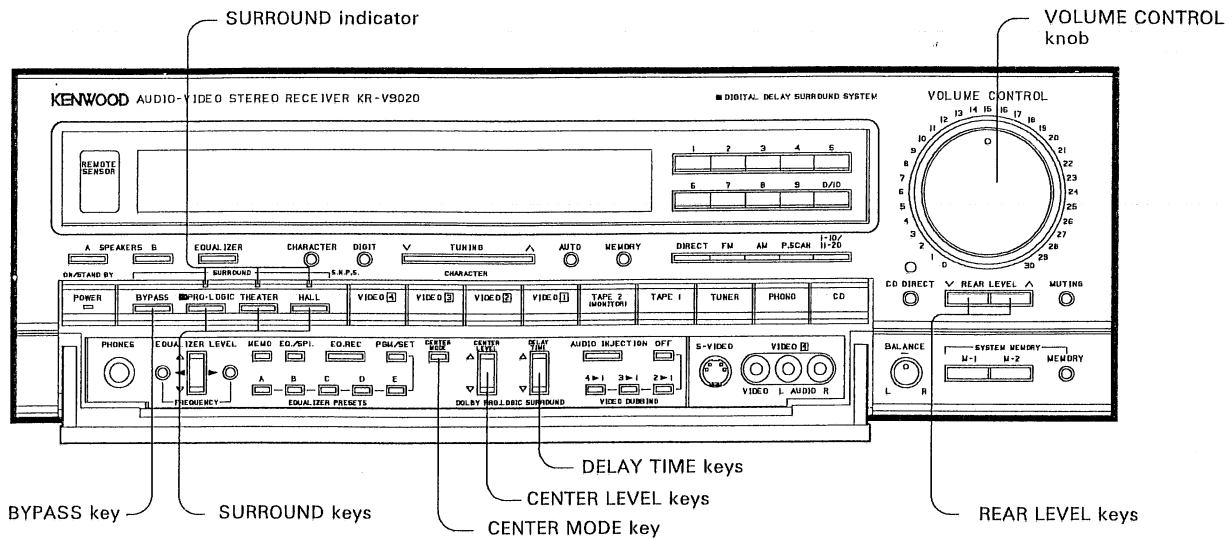

The reason why the sound you experience in concert halls or stadiums is so real and live is that the sound comes not only from the front but also from the surroundings. To reproduce such conditions as close as possible to reality, this unit is equipped with three Surround modes (PRO-LOGIC, THEATER, HALL). In addition, three Dolby PRO-LOGIC modes—NORMAL, WIDE, and PHANTOM—are provided to enhance the sound directivity and to provide the sound with a more surrounding, powerful "being-there" feeling.

Note on Dolby Surround

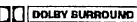
Video softwares marked with  are encoded with Dolby Surround information. This unit incorporates a Dolby Pro Logic Surround decoder for recreating the Dolby Stereo theatre experience in your home with Dolby Surround-Encoded source material.

To obtain this effect, press the  PRO-LOGIC key to ON.

■ Surround modes

PRO-LOGIC mode

The PRO-LOGIC mode is used when playing a source encoded with Dolby Surround signals. (The following modes can be selected by pressing the CENTER MODE key repeatedly.)

NORMAL:

Select this mode when the signal output from the CENTER OUT jack on the rear panel is reproduced through a small center speaker. Low frequencies below 100 Hz in this signal are distributed to the left and right front speakers, and frequencies above 100 Hz are reproduced through the center speaker.

WIDE:

The entire signal output from the CENTER OUT jack on the rear panel is sent to the center speaker, without the low frequencies below 100 Hz being routed to the left and right speakers as in case of the Normal mode.

Set to this mode if the speaker used as the center speaker is the same type of speaker as those used for the front left and right positions.

PHANTOM:

This mode allows the PRO-LOGIC effect to be enjoyed even when a center speaker is not connected. In this case, the center signal is distributed to the left and right front speakers.

THEATER Surround mode

This mode provides a three-dimensional effect similar to that of a movie theater. With this mode, you can enjoy a Surround sound effect similar to Dolby Surround sound even when playing a video program which is not encoded with the Dolby Surround system.

HALL Surround mode

This mode provides a natural reverberation effect. When used with a normal source, you can enjoy the being-there feeling or "presence" as in the hall.

MANUFACTURED UNDER LICENSE FROM DOLBY LABORATORIES LICENSING CORPORATION. ADDITIONALLY LICENSED UNDER ONE OR MORE OF THE FOLLOWING PATENTS; U.S. NUMBERS 3,632,886, 3,746,792 AND 3,959,590; CANADIAN NUMBERS 1,004,603 AND 1,037,877. "DOLBY" AND THE DOUBLE-D SYMBOL  ARE TRADEMARKS OF DOLBY LABORATORIES LICENSING CORPORATION.

How to make adjustments for the Dolby Pro-Logic mode

■ INPUT BALANCE adjustment

With this unit, the INPUT BALANCE is adjusted automatically.

- "This unit features an automatic input balance control, eliminating the need to adjust L/R input balance for different sources and optimizing performance of the Dolby Pro Logic Surround decoding by minimizing crosstalk."

■ Surround Level adjustment

NORMAL/WIDE

1. Select "NORMAL" or "WIDE" with the CENTER MODE key.
2. Press the TEST TONE ON/OFF key on the remote control at the listening position.
 - Test noise will be heard.
3. Press the TEST TONE MODE key on the remote control.
 - Each time the key is pressed, the tone will be heard from one of four positions in the following order:

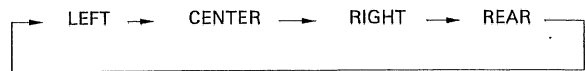

4. Adjust the CENTER LEVEL and REAR LEVEL keys so that the output volumes from the five speakers are almost identical when listened from the listening position.
5. Press the TEST TONE ON/OFF key to OFF.

PHANTOM

1. Select "PHANTOM" with the CENTER MODE key.
2. Press the TEST TONE ON/OFF key on the remote control at the listening position.
 - Test noise will be heard.
3. Press the TEST TONE MODE key on the remote control.
 - Each time the key is pressed, the tone will be heard in one of three positions in the following order:

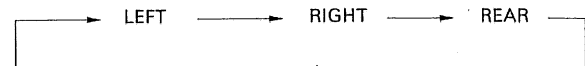

4. Adjust the REAR LEVEL keys so that the output volumes from the four speakers are almost identical when listened from the listening position.
5. Press the TEST TONE ON/OFF key to OFF.

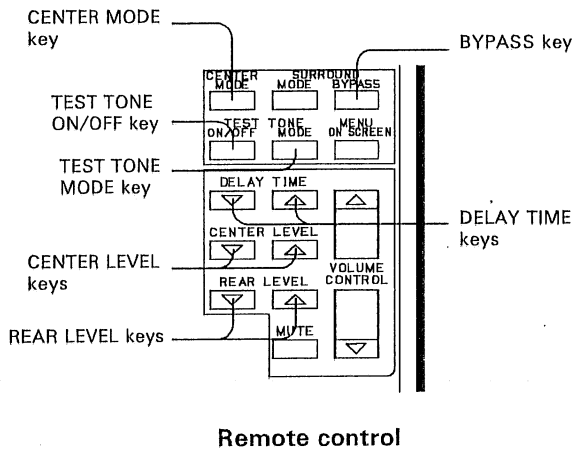

Remote control

Surround effects

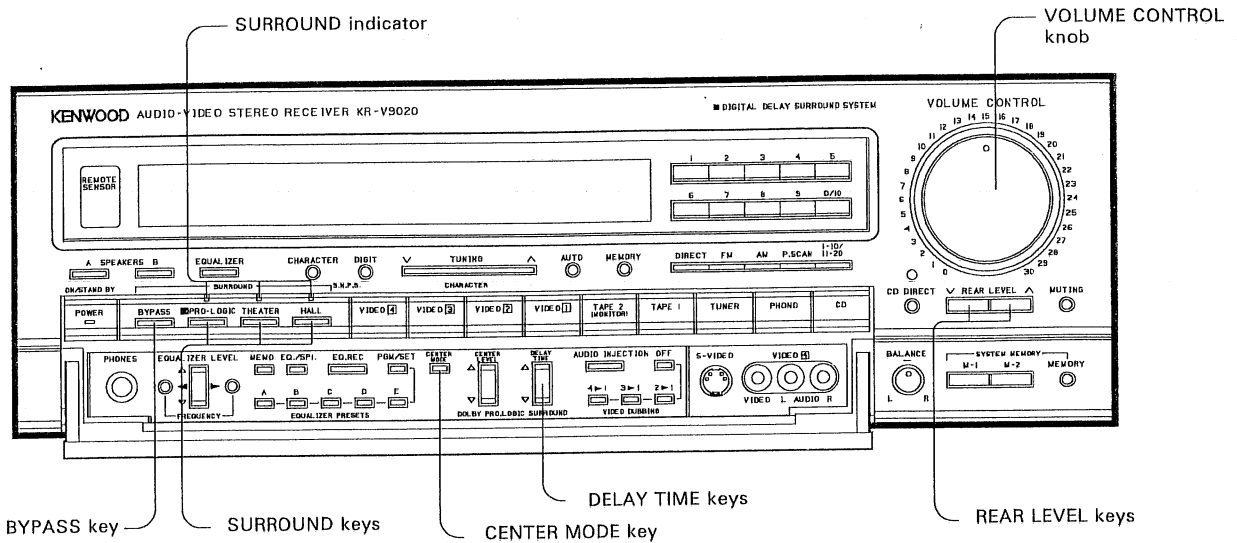

■ THEATER SURROUND, HALL SURROUND adjustment

1. Press the THEATER or HALL Surround key.
2. Adjust the rear speaker output level with the REAR LEVEL control keys.
 - The REAR LEVEL control range is from +20 dB to -50 dB of the front speaker level.

■ Delay time adjustment

The output signal from the rear speakers is delayed slightly than that of front speakers for each Surround mode separately. The delay time can be adjusted as desired separately for the PRO LOGIC and THEATER SURROUND modes. The delay time of the HALL SURROUND mode is fixed at 30 ms and cannot be adjusted.

1. Press the PRO LOGIC or THEATER key.
2. Adjust the delay time using the DELAY TIME keys.
 - For the PRO LOGIC mode, the delay time can be adjusted between 15 ms and 30 ms in 1.5 ms steps.
 - For the THEATER SURROUND mode, the delay time can be adjusted between 0 ms and 30 ms in 1.5 ms steps.

■ To play sound with the Surround effect

1. Set the SURROUND key to ON.
 - The selected Surround mode indicator lights.
2. Select the source to be played with the surround sound effect, and play it.
3. Adjust the volume level.
 - The VOLUME CONTROL allows you to increase or decrease the volume level of all of the front, rear and center channels simultaneously.

Note:

When this unit is in DOLBY PRO LOGIC SURROUND mode, the graphic equalizer will operate only in "SET" mode. Otherwise, graphic equalizer operation will be canceled by the "DEFEAT" function. Therefore, when it is desired to use the graphic equalizer when the unit is in DOLBY PRO LOGIC SURROUND mode, press the PGM/SET key to set to "SET" mode.

■ To release the Surround mode

- Press the BYPASS key.
- Be sure to set the BYPASS mode when the Surround effect is not required.

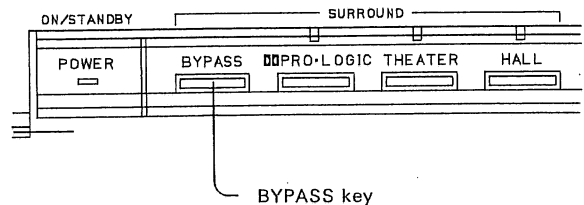

Standard arrangement

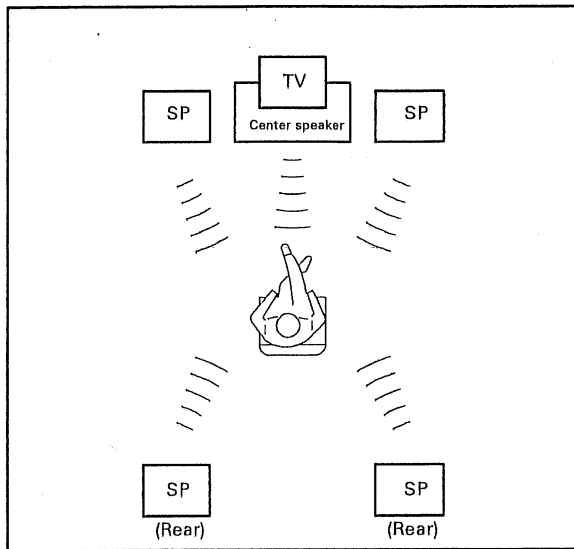

■ Arranging the speakers

A variety of rear speaker arrangement patterns are possible according to room size, reverberation characteristics, etc.

The arrangement pattern given here is typical example for effective Surround sensation. The given example is only suggestion. Arrange the speakers according to your individual taste.

System memory

The required playback condition can be stored in memory for each music source (tape, compact disc, phonograph record (disc), or broadcasting program), so that the same balance (between front and rear channels) and the same equalizer pattern, etc. can be recalled at any time instantly.

Two types of settings can be stored in memory, and by pressing the appropriate SYSTEM MEMORY (M-1 or M-2) key you can recall the preset sound field condition instantly.

Stored contents:

The stored contents in the System Memory are as follows:

- Input source (CD, PHONO, TUNER, TAPE, VIDEO, etc.) (including TAPE 2)
- Preset channel in the TUNER position
- Audio injection
- EQUALIZER key setting (ON/DEFEAT)
- EQ. REC key setting (ON/OFF)
- Preset channel of the equalizer pattern
- SURROUND setting (ON/OFF)
- SURROUND mode
- Center mode
- Center level
- Delay time
- Rear level
- Video monitor out
- SPEAKERS A, B
- CD DIRECT ON/OFF

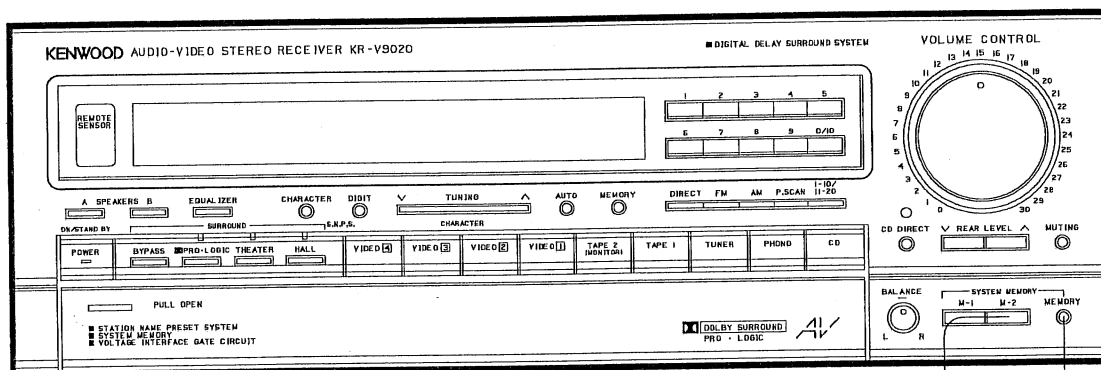

SYSTEM MEMORY M-1, M-2 keys

SYSTEM MEMORY key

■ How to preset the System Memory

1. Set the playback conditions as desired.
 - When selecting the tuner or equalizer, be sure to designate the preset channel.
2. Press the SYSTEM MEMORY key.
 - The MEMORY indicator lights and the "SYSTEM MEMORY" indication appears in the display (for 5 seconds).
 - If the "CAN NOT MEMORIZE" indication is displayed, the tuner frequency or equalizer pattern will not be preset in memory.After presetting the playback condition for each channel, press the MEMORY key again.

Note:

If the contents of a preset channel is changed after being designated as the tuner or equalizer section channel for System Memory, the contents of the System Memory channel will also be changed.

■ How to recall System Memory

1. Press the M-1 or M-2 key.
 - The display shows "SYSTEM MEMORY 1" or "SYSTEM MEMORY 2" for about 2 second, and the settings of each section are changed to the preset contents.
2. Readjust the setting of each section as required.
 - When PHONO is selected as the input source, with a system-controlled turntable connected, the turntable will automatically start playing by recalling the System Memory. Therefore, be sure to set a record on the platter of the turntable before activating the System Memory function.
 - In the same way, when a system-controlled tape deck or CD player is connected to this unit, the tape deck or CD player can be started automatically by activating the System Memory function.

On-screen display

* * TUNER PRESET * *		
1 K I K I	8 K I S S	15 K L M N
2 - - - -	9 - - - -	16 - - - -
3 - - - -	10 - - - -	17 - - - -
4 - - - -	11 W H Y Z	18 - - - -
5 - - - -	12 - - - -	19 - - - -
6 - - - -	13 - - - -	20 - - - -
7 - - - -	14 - - - -	

ON SCREEN STANDBY

ON SCREEN OFF

* * TEST TONE * *		
CENTER		
LEFT	///	RIGHT
///		///
///	REAR	///
CENTER	LEVEL	+ 8 DB
REAR	LEVEL	+ 12 DB

1. SCREEN 4 (TUNER PRESET):

- Displays the contents of the tuner preset channels.

2. SCREEN 5 (ON SCREEN STANDBY):

- Shows the standby mode for the on-screen display. The screen shown in the figure appears for 5 seconds, then goes out.
- In this mode, when a relevant key is pressed, the corresponding screen will be displayed for 5 seconds, then go out.

3. SCREEN 6 (ON SCREEN OFF)

- Shows that the on-screen display is turned OFF. When the power is switched ON, the figure shown on the left will be displayed from 5 seconds, then go out.
- There is no on-screen display in this mode.
- Set to this mode when noise interferes with the video picture.

4. TEST TONE DISPLAY

- This screen appears when the TEST TONE mode is engaged. The "///" (darkened cursor) blinks at the position where the test tone is being output.

Note:

The position of the on-screen display (on the TV screen) may vary depending on the video software being played.

Remote control operation

■ Loading batteries into the remote control unit

1. Remove the battery cover.
While gently pressing the battery cover located on the rear of the remote control unit, slide it in the direction of the arrow.

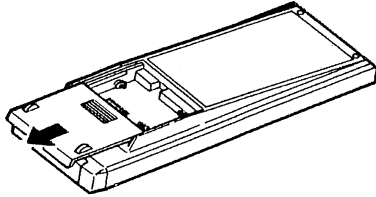

2. Insert the provided batteries. Take care to respect the battery polarity (+, -).

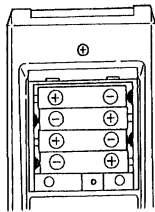

3. Be sure to close the cover after inserting.

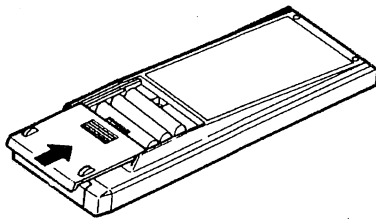

Note:
The batteries provided are to be used for checking the remote control operations. Their service life may be short.

■ Battery replacement

1. If the TRANSMIT indicator will not light up when an operation key is pressed, the batteries may be exhausted. In this case, replace them with new batteries. It is recommended to use alkaline batteries (LR03 or AM-4 type) with long life.
2. The programmed contents are not immediately lost when the batteries are removed for replacement. However, they could be lost if the unit is left without batteries for more than 3 minutes. In such a case, the programming should be performed again. The function signals of the non-learning, or fixed, keys are not lost even in this case.

Note:
Avoid using old and new batteries together, as this may cause corrosion.

■ Operations

1. Connect the power plug of the receiver to an AC outlet.
 - The receiver enters the power standby mode and the power standby indicator lights.
2. Press the POWER key of the remote control unit or the POWER key of the receiver.
 - The receiver enters the power ON mode.
3. The various functions of the receiver can be operated with the keys of the remote control unit.

Note for remote control operation

After pressing one of the operation keys, when the next operation is required, press the next operation key firmly after an approx. 1 second interval.
If the next operation key is pressed immediately after the previous key, misoperation may result.

■ Operating range of the remote control unit

The operating range of the remote control unit may differ according to temperature, humidity, or using conditions, however, it is defined approximately as shown in the figure below:

For controlling the receiver, TV and VCR

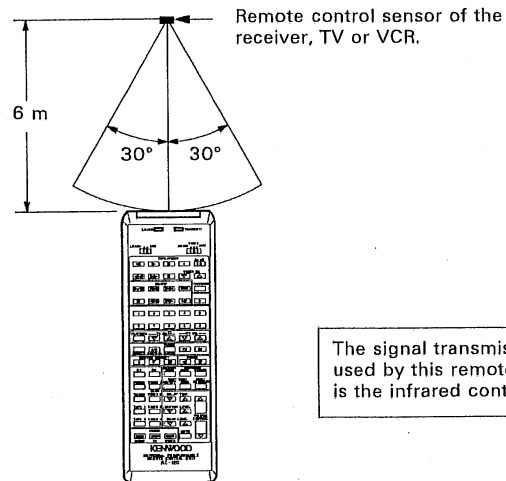

Note:
Malfunction may occur in case direct sunlight or the light of a high - frequency lighting fluorescent lamp enters the remote control light receptor. In such a case, change the installation position of the unit so that the malfunction does not occur.

Remote control operation

The remote control unit (RC-120) is capable of the remote control of this unit as well as other KENWOOD system components connected to this unit via system control cords, *KENWOOD VCR and *TV. In addition, it is also possible to program the remote-controllable functions of other A/V components in the memory of RC-120, making it a multi-purpose remote controller for the whole of your system.

Names and operation of controls

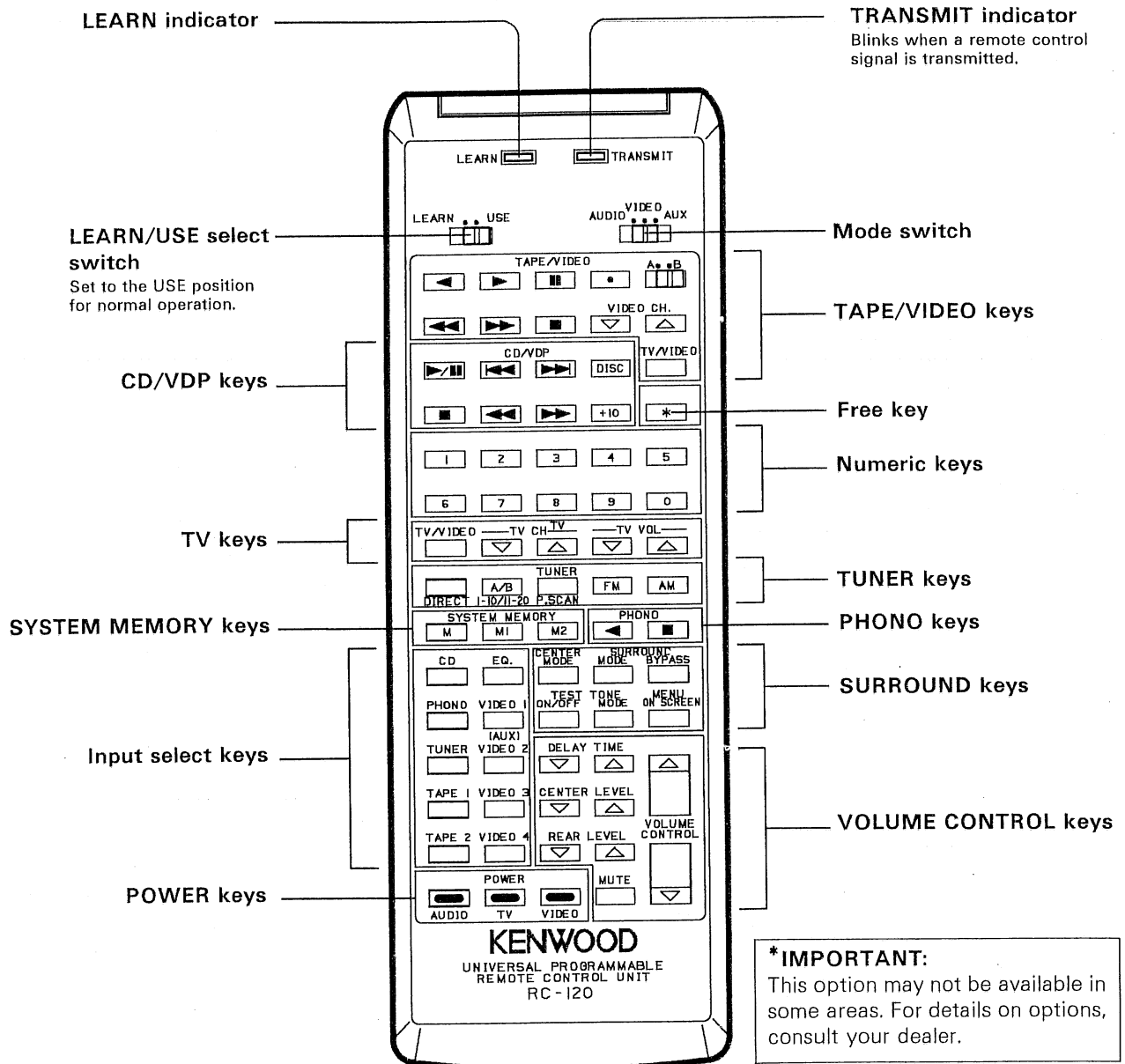

Remote control operation

1. The whole of the keys can be used in three ways (three sides) by selecting the mode switch position. The AUDIO and VIDEO sides contains the initial programming of KENWOOD-original remote-control codes. (Please refer to "Original functions of keys".)

- AUDIO position: For the remote control of KENWOOD system components and KENWOOD TV.
- VIDEO position: For the remote control of KENWOOD VCR, KENWOOD TV and part of KENWOOD system components.
- AUX position: All keys are available, that is, able to store the programming of other remote control functions.

2. The remote control functions of other A/V components can also be programmed under the keys on the AUDIO and VIDEO sides as well as on the AUX side. However, when any information is programmed under a key on the AUDIO or

Original functions of keys

LEARN/USE select switch
Set to the USE position.

Mode switch
Set to the AUDIO
or VIDEO

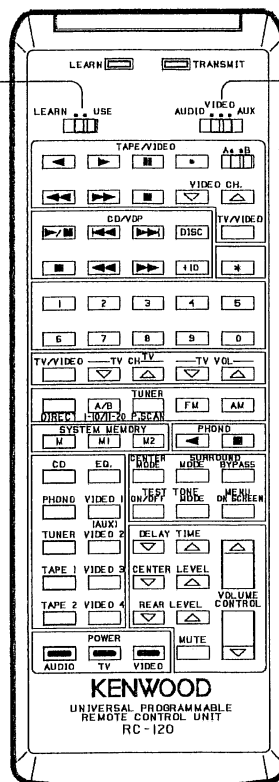

Caution in Remote Control

- If the CD player is not equipped with the System Control jack, it cannot be operated properly from this remote control unit. In such a case, please use the remote control unit provided with the CD player.
- If any of the following KENWOOD component models is used, this remote control unit cannot be used to control the CD manual search function or to make entries with the numeric keys (1 to 0 and +10): DP-M97, DP-57, DP-47

■ TAPE deck control keys (Mode switch: AUDIO)

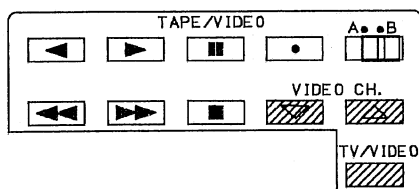

Use the A/B select switch to specify the A deck or B deck of a dual-transport cassette deck.
The darkened keys (marked "▨") do not function at this time.

Note:

When it is necessary to press the fast forward key after the rewind key, be sure to press the stop key before pressing the fast forward key.

■ VIDEO deck control keys (Mode switch: VIDEO)

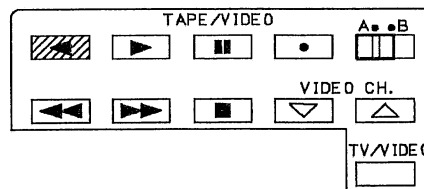

The darkened keys (marked "▨") do not function at this time.

When remotely controlling the KV-D957S from KENWOOD (for U.S.A. and military), set the A/B select switch to A.

VIDEO CH keys:

Pressing the key shifts the channel tuned on the VIDEO deck upward, and pressing the key shifts it downward.

TV/VIDEO key:

Every time this key is pressed, the output from the video deck is switched between the TV channel RF output and video output.

Remote control operation

■ CD player control keys

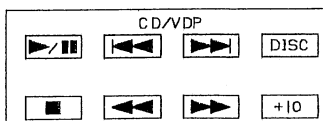

Mode switch: AUDIO

These keys allow the same operations as the keys with the same names on the CD player.

The DISC key is for use exclusively with a multiple CD player. Pressing the DISC key allows one of DISC 1 to DISC 6 to be selected in the following cycle.

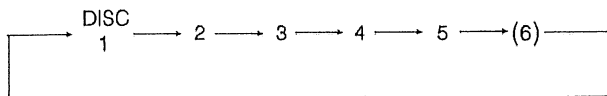

■ Numeric keys (1 to 0)

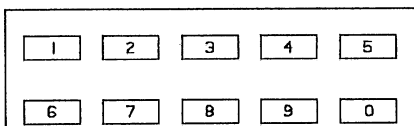

Mode switch: AUDIO

When the CD or TUNER input selector key is selected, these keys can be used in place of the numeric keys on the CD player or receiver, respectively.

Mode switch: VIDEO

The numeric keys can be used in place of the TV channel select keys.

■ TV set control keys

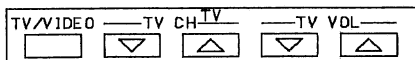

Mode switch: AUDIO or VIDEO

TV VOL keys:

Pressing the key increases the volume of the TV set, and pressing the key decreases it.

TV CH keys:

Pressing the key shifts the channel tuned on the TV set upward, and pressing the key shifts it downward.

TV/VIDEO key:

Every time this key is pressed, the input to the TV set is switched between the TV signal and the external video signal.

■ TUNER control keys

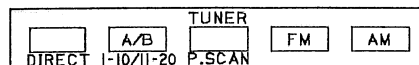

Mode switch: AUDIO or VIDEO

These keys allow the same operations as the keys with the same names on the receiver.

■ Turntable (PHONO) control keys

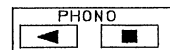

Mode switch: AUDIO or VIDEO

The Play () and Stop () keys are provided.

■ System memory keys

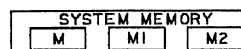

Mode switch: AUDIO or VIDEO

These keys allow the same operations as the keys with the same names on the receiver.

■ Equalizer key

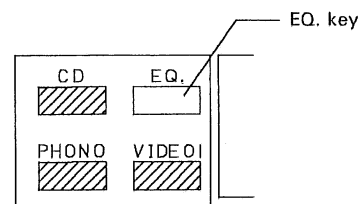

Mode switch: AUDIO or VIDEO

Every time the EQ key is pressed, the equalizer of this unit can be switched ON/DEFEAT or ten preset equalizer patterns can be changed over in the following cycle.

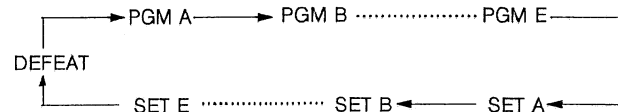

- When DOLBY PRO LOGIC SURROUND is ON, "PGM" patterns will not be selected.

■ Input selector keys

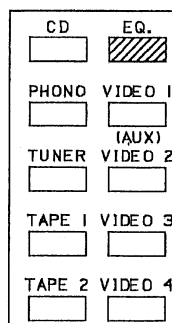

Mode switch: AUDIO or VIDEO

These keys have the same functions as the input selector keys on the receiver.

■ Surround keys

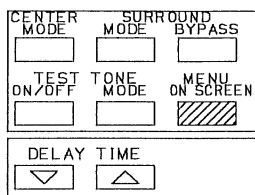

Mode switch: AUDIO or VIDEO

The CENTER MODE key, BYPASS key, and DELAY TIME key function in the same way as those on the front panel of the KR-V9020.

SURROUND MODE key:

Each time this key is pressed, the Surround mode changes in the following order:



TEST TONE ON/OFF key:

Turns the test tone ON and OFF when the DOLBY PRO-LOGIC mode is selected.

TEST TONE MODE key:

Each time this key is pressed, the test tone output position is changed in the following order:

(NORMAL or WIDE mode)

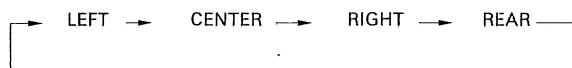

(PHANTOM mode)

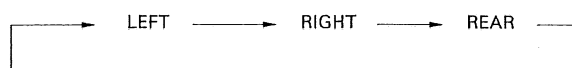

■ Volume level keys

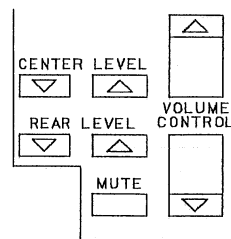

Mode switch: AUDIO or VIDEO

VOLUME CONTROL keys:

Pressing the Δ key rotates the VOLUME CONTROL on the main body of the receiver clockwise to increase the volume, and pressing the ∇ key rotates it counterclockwise to decrease the volume.

Other keys allow the same operations as the keys with the same names on the receiver.

■ MENU ON SCREEN key

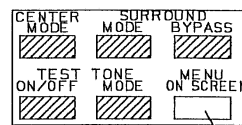

MENU ON SCREEN key

Mode switch: AUDIO or VIDEO

Every time this key is pressed, the on-screen display modes are changed over in the following order:

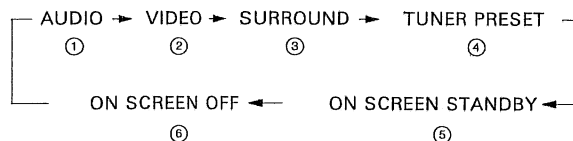

■ POWER keys

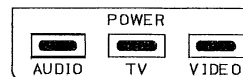

Mode switch: AUDIO or VIDEO

AUDIO key:

Switches the power of the receiver to ON/STANDBY (OFF).

TV key:

Switches the power of the TV set to ON/STANDBY (OFF).

VIDEO key:

Switches the power of the video deck to ON/STANDBY (OFF).

Remote control operation

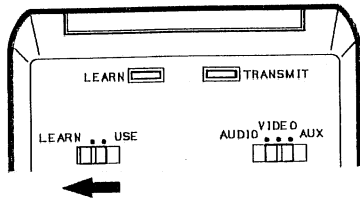

Other remote control unit

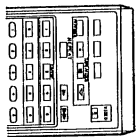

2 ~ 5 cm

RC-120

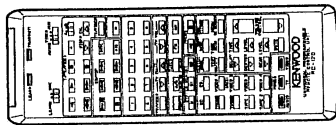

■ To program the remote control functions of other remote control units into the RC-120:

1. Set the LEARN/USE select switch to the LEARN position, and set the AUDIO/VIDEO/AUX select switch to the desired position.

2. Place the RC-120 and the other remote control unit so that their heads (transmission ends) face each other. (Leave a distance between the units of about 2 ~ 5 cm or 0.8 ~ 2 inches.)

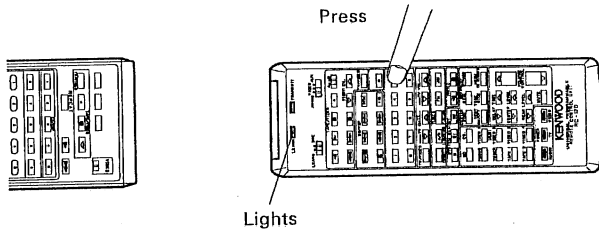

3. Press one of the learning keys on the RC-120. The LEARN indicator will light.

Example: To program the REPEAT key of the other remote control unit

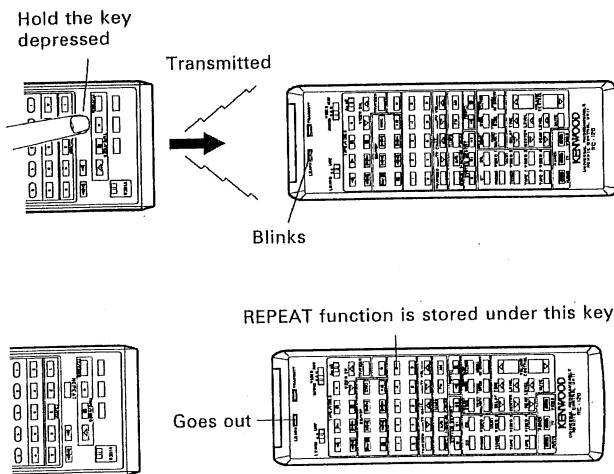

4. Press the key to be programmed on the other remote control unit and hold it depressed.

5. When the LEARN indicator on the RC-120 blinks twice and then goes out, the programming operation is completed. When the programming operation is completed, release your finger from the key on the other remote control unit.

Note:

Be sure to hold the key to be programmed on the other remote control unit depressed until the LEARN indicator goes out.

• To program other remote control functions, repeat the procedure outlined in steps (3) to (5).

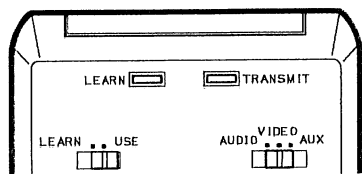

Set to USE.

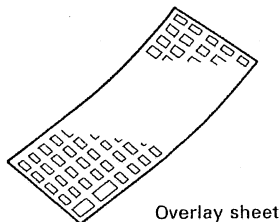

Overlay sheet

■ To erase the entire programmed contents

With a single procedure, you can erase all of the remote control functions which have been programmed under keys in each mode (AUDIO, VIDEO, and AUX).

1. Set the LEARN/USE switch to the LEARN position.
2. Press a programmable key (any programmable key may be pressed).
 - The LEARN indicator lights.
3. Remove the battery cover from the back of the remote control unit.
4. Press the reset key located inside the battery case using the tip of a ball-point pen or similar instrument.
 - All of the programmed contents are erased and the remote control unit returns to its initial condition.

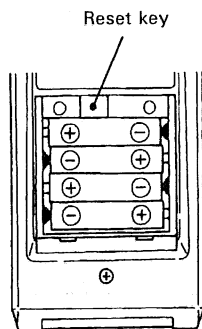

■ To check the programmed contents during programming

1. Check that the LEARN/USE select switch is in the USE position.
2. Press the key to be checked.
3. Verify that the component to be operated works correctly.

■ To change the programmed contents

Perform the programming operation again. The previously programmed contents will be canceled automatically, and the newly programmed contents will be maintained in memory.

■ Normal operation of the remote control unit

1. Set the LEARN/USE select switch to the USE position.
2. Press a key under which another remote control function has been programmed.

The TRANSMIT indicator blinks and the target component operates as intended.

■ Overlay sheet

The provided overlay sheet offers a convenient way to record and recall the contents programmed under the various operation keys.

Write the programmed key contents on the overlay sheet with an oil-based felt-tipped marker or pencil. To erase, use a conventional eraser.

Most audio/video components use the same infrared remote control coding system. Therefore, the RC-120 can memorize most of the functions of other remotely-controlled components. Please read this manual and the instruction manuals provided with your other A/V components carefully before programming the remote control functions of the other components.

Notes:

1. If the optical output level of the other remote control unit is high, programming may not be carried out correctly. If this occurs, separate the RC-120 and the other remote control unit by a greater distance and perform the programming procedure again.
2. If the LEARN and TRANSMIT indicators blink simultaneously during programming, this indicates either that the key being programmed cannot be programmed or that programming has not been performed completely. If this occurs, perform the programming procedure again.
3. Remote control functions using specially-coded signals or signals other than infrared signals cannot be programmed. Programming is also impossible when the RC-120's memory capacity becomes full.
4. The LEARN indicator goes out 30 seconds after a learning (programmable) key is pressed. After this, programming is impossible. To continue programming, press the learning (programmable) key again.
5. When two or more learning (programmable) keys are pressed at the same time, the remote control function of the other remote control unit will be stored under the key which was pressed last.
6. Do not program the remote control functions of equipment other than A/V components, such as air conditioners, etc.

In case of difficulty

What appears to be a malfunction may not always be serious. If your unit should not perform as expected, consult the table below to see if the problem can be corrected before seeking help from your dealer or service representative. Even when the POWER is turned ON, this unit may not function correctly due to external noise or interference, etc. In such a case, disconnect the power cord from the AC outlet, and after about 10 seconds, plug it again then turn the POWER ON again.

Symptom	Cause	Remedy
No power, no sound.	1. Power cord not plugged in. 2. Poor connection at wall outlet. Power outlet inactive.	1. Check plug contact. 2. Check outlet using a lamp or other appliance (outlet may be controlled by a wall switch).
No sound from left and right.	1. Speaker cords disconnected. 2. Speakers switched off.	1. Check speaker connections. 2. Check speaker switch.
Sound from left or right, but not both.	1. Poor speaker connections. 2. Defective speaker.	1. Check connections at both ends of speaker cord. 2. Reverse speakers. If problem stays with speaker, have speaker checked.
FM broadcast too noisy. Sufficient reception is impossible.	1. Indoor antenna is used. 2. Poor connection of the antenna cable.	1. Use an outdoor antenna. 2. Connect the antenna cable correctly.
Dubbing from TAPE 2 to TAPE 1 is impossible.	The Input Selector TAPE 1 button is pressed. (The TAPE 1 indicator lights in the display.)	Switch the input selector to a source other than TAPE 1.
Graphic equalizer recording is impossible in the VIDEO DUBBING mode.	The AUDIO INJECTION key is not pressed ON.	Press the AUDIO INJECTION key to ON. Check that the AUDIO INJECTION indicator lights up, then press the EQ REC key.
No sound from the rear speakers.	1. Surround mode is set to BYPASS. 2. Rear level is set to a low level. 3. Surround mode is set to DOLBY PRO-LOGIC or THEATER, and a monaural source is used.	1. Set to the required Surround mode. 2. Increase the rear level to an appropriate level. 3. Use a stereo or surround-encoded source.
Remote control unit does not function.	1. Unit is operated from too great a distance. 2. Batteries are nearly exhausted.	1. Operate from a position closer to the front panel. 2. Replace all four batteries with new ones.
Delay time adjustment impossible.	Surround mode is set to BYPASS or HALL.	Delay time cannot be adjusted in the BYPASS or HALL mode.
Occurs during AM reception only	Cause	Remedy
High-frequency whistle especially at night.	Interference from TV set.	Turn off TV set. If problem disappears, try relocating TV set.
Intermittent buzz or cracking sound.	1. Lightning. 2. Fluorescent lamps starting. 3. Appliance or furnace starting.	1. No remedy. 2. Try reversing AC plug. 3. Try reversing AC plug.
Occurs during FM reception only	Cause	Remedy
Hiss that gets worse in stereo reception.	Very weak antenna input signal.	Consider an outdoor antenna installation. In areas remote from the transmitter, a 5 to 8 element antenna designed exclusively for FM is suggested.
Rhythmic static or popping noises.	Automobile ignition noise, especially evident when receiving weak signals.	Review antenna installation. Site the antenna as far from the street as possible and use coaxial cable.
STEREO indicator fails to light during stereo broadcast.	Another possible effect of a very weak signal.	Antenna system needs attention (see above).

Speaker protection circuit

If " * PROTECTION ON * " blinks on the display window, immediately turn power off by pressing the POWER key (keys others than the POWER key are not accepted). The positive (+) and negative (-) speaker cords may possibly be short-circuited.

If they are short-circuited, connect the cords properly and turn power on again.

Note:

Do not use contact cleaner because it could cause a malfunction. Be specially careful against contact cleaners containing oil, for they may deform the plastic components.

Specifications

AUDIO SECTION

Rated Power Output
(Front)

130 watts per channel minimum RMS, both channels driven at 8 ohms, from 20 Hz to 20,000 Hz with no more than 0.008% total harmonic distortion.

(Rear)

20 watts per channel minimum RMS, both channels driven at 8 ohms at 1 kHz with no more than 0.9% total harmonic distortion.

Total Harmonic Distortion

(1 kHz, 8 ohms at 130 W) 0.003%

Input Sensitivity/Impedance

PHONO (MM) 2.5 mV/47 kohms
CD, TAPE 200 mV/47 kohms
VIDEO 250 mV/47 kohms

Frequency Response

CD 10 Hz - 100 kHz +0 dB
-3 dB

Signal-to-Noise Ratio (IHF-A)

PHONO (MM) 79 dB
CD, TAPE 100 dB
VIDEO 90 dB

Graphic Equalizer

Center Frequencies 60 Hz, 150 Hz, 400 Hz, 1 kHz,
2.4 kHz, 6 kHz, 15 kHz

Control Range ± 12 dB

VIDEO SECTION

Television format NTSC
VIDEO Inputs/Outputs 1 Vp-p, 75 ohms unbalanced

FM TUNER SECTION

Tuning Frequency Range 87.5 MHz - 108 MHz

Antenna Impedance 75 ohms unbalanced

Sensitivity IHF 10.8 dBf (0.95 μ V at 75 ohms)

Signal-to-Noise Ratio at 65 dBf (IHF)

MONO 80 dB

STEREO 74 dB

Total Harmonic Distortion at 1,000 Hz

MONO 0.1%

STEREO 0.2%

Frequency Response 30 Hz - 15 kHz +0.5 dB
-2.0 dB

Stereo Separation 50 dB at 1 kHz

Selectivity (± 400 kHz) 53 dB

AM TUNER SECTION

Tuning Frequency Range

530 kHz - 1,610 kHz

(with the AM tuning interval set at 10 kHz)

531 kHz - 1,602 kHz

(with the AM tuning interval set at 9 kHz)

Usable Sensitivity 10 μ V/(400 μ V/m)

Signal-to-Noise Ratio 50 dB

Total Harmonic Distortion 0.3%

Selectivity 25 dB

GENERAL

Power Consumption 5A USA and Canada Models
..... 500 W Others

Dimensions 440 (W) \times 162 (H) \times 420 (D) mm
(17-5/16") \times (6-3/8") \times (16-9/16")

Weight (Net) 14.7 kg (32.4 lb)

Note:

KENWOOD follows a policy of continuous advancements in development. For this reason specifications may be changed without notice.

For the U.S.A.

FCC WARNING:

This equipment may generate or use radio frequency energy. Changes or modifications to this equipment may cause harmful interference unless the modifications are expressly approved in the instruction manual. The user could lose the authority to operate this equipment if an unauthorized change or modification is made.

KENWOOD